

2025
CATALOGUE

KITCHEN WARDROBE & HARDWARE



Sterling[®]

Technology from *VEDUGGIO* Italy

DRAWER SYSTEMS

PANTRY UNITS

BOTTLE PULL OUTS

ANCILLARIES

HINGES

ELEVATORS

PROFILE



Coming from Modular Kitchen & Furniture manufacturing background, no one understands hardware & fittings better than us. Our 360 degree understanding of the subject has helped us design our products for functionality, durability & ease of installation.

Our quality standards are based on European & international standards, on guidelines issued by professional bodies & our own in house quality criteria Team STERLING has a collective industry experience of 50 years. Our strengths include core competencies in manufacturing, an ever widening product range, stringent quality standards, affordable price & All India distribution network.

Lifetime Warranty

Our products pass rigorous tests for performance & any stress they might have to withstand in normal use. As a testimony to that we offer lifetime warranty on performance of our products subject to certain conditions.

Free Design Service

Making a new modular kitchen or wardrobe?

We offer free design solution to suit every taste & budget

Designers at STERLING can provide you customize design & bill of quantity at zero cost.

For STERLING its always Customer First

STERLING is a customer centric organization & always put the needs & requirement of customers ahead of anything & everything else. Our entire team including production, marketing & support services are all focused on customer & their needs. We constantly take feedbacks from our customer & try to provide them best quality driven products & services.



Sterling offers largest collection of luxurious colours and finishes for drawers and organizers in India.



For Enquiry & Support

Email: sterlingwp01@gmail.com

Customer Care No. 8059843498/8570066253





CONTENTS

Slim Tandem Box

PAGE

1-2

Slim Tech Tandem

PAGE

3-4

Galleria Model

PAGE

5-6

SS PVD Basket & Aluminium Basket

PAGE

7-9

Partitions & Silico Glass Series

PAGE

10-11

Space Ladder & Pantry

PAGE

12-25

Magic Corner, Carouse &
Bpo-MPO-SPO

PAGE

26-31

Side Mounting Pullout &
Wire Baskets

PAGE

32-35

Bins & Detergent Racks,
Wire Basket Money Series

PAGE

36-37

Wire Accessories, Pull Down Unit
Rolling Shutters

PAGE

38-41

CUTLERY TRAY

PAGE

42-43

Wicker Basket, Dish Rack With
Drip Tray, Sliding Double &
Auto Lid Dustbin

PAGE

44 - 46

Hinges

PAGE

47 - 51

Hinges - Corner Hinge
Drawer & Slides

PAGE

52-53

Quadro Slide & Elevators

PAGE

54 - 56

Aluming-Profile & Handles
PVD SS Profile

PAGE

57-61

ANCILLARIES

PAGE

62-65

Wardrobe & Basket

PAGE

66 - 70

Innovation, Elegance, Quality...!

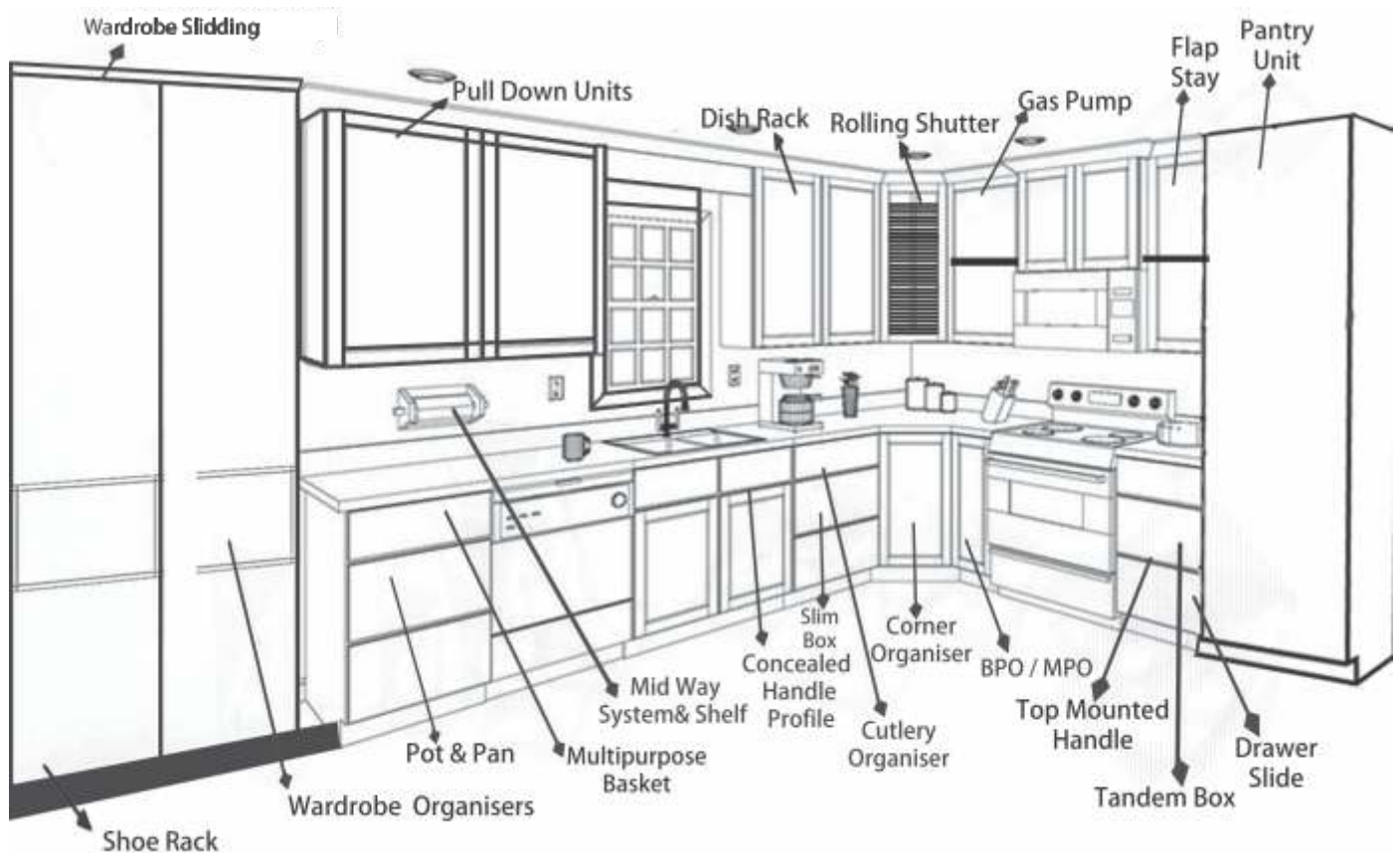

Drawer Systems

A place for everything and everything in place. Largest collection of sizes, colour and types.

Hinges

Hinges though a small component but is a specialised subject in its own. Every furniture require different hinge as per its application.

Elevators

Products of convenience and style. They are the best example to showcase minimum effort and maximum result.

Wardrobe Systems and Accessories

Organizing a wardrobe is no more a challenge, these products help you to organise your space as per your mood.

Ancillaries

Small is Big. These small components plays a vital role in putting your dream together.

Organisers

Modern kitchen should have organisers for optimal usage of space, options available for all needs and budget

Racks and Bins

A modular kitchen is incomplete without racks and bins. They hold everything that we think is not so significant.

Midway Systems and Shelves

A must have for those who are perfectionist, as it perfectly organise the available space which is generally considered as waste.

Profile and Handles

Handel less feel, Colours to match your interiors, many options to experiment and play.

ROSE GOLD SS (PVD)



Product	Code	Size(mm)	MRP
Slim Box 4 - Inches	STB 4 (R-D) S.S 18"	450	5240
	STB 4 (R-D) S.S 20"	500	5240
	STB 4 (R-D) S.S 22"	550	6050
Slim Box 6 - Inches	STB 6 (R-D) S.S 18"	450	5740
	STB 6 (R-D) S.S 20"	500	5740
	STB 6 (R-D) S.S 22"	550	6550
Slim Box 8 - Inches	STB 8 (R-D) S.S 18"	450	6240
	STB 8 (R-D) S.S 20"	500	6240
	STB 8 (R-D) S.S 22"	550	7050

GOLD SS (PVD)



Product	Code	Size(mm)	MRP
Slim Box 4 - Inches	STB 4 (Y-D) S.S 18"	450	5240
	STB 4 (Y-D) S.S 20"	500	5240
	STB 4 (Y-D) S.S 22"	550	6050
Slim Box 6 - Inches	STB 6 (Y-D) S.S 18"	450	5740
	STB 6 (Y-D) S.S 20"	500	5740
	STB 6 (Y-D) S.S 22"	550	6550
Slim Box 8 - Inches	STB 8 (Y-D) S.S 18"	450	6240
	STB 8 (Y-D) S.S 20"	500	6240
	STB 8 (Y-D) S.S 22"	550	7050

BLACK SS (PVD)



Product	Code	Size(mm)	MRP
Slim Box 4 - Inches	STB 4 (Z-D) S.S 18"	450	5240
	STB 4 (Z-D) S.S 20"	500	5240
	STB 4 (Z-D) S.S 22"	550	6050
Slim Box 6 - Inches	STB 6 (Z-D) S.S 18"	450	5740
	STB 6 (Z-D) S.S 20"	500	5740
	STB 6 (Z-D) S.S 22"	550	6550
Slim Box 8 - Inches	STB 8 (Z-D) S.S 18"	450	6240
	STB 8 (Z-D) S.S 20"	500	6240
	STB 8 (Z-D) S.S 22"	550	7050

Special Features

- Impressively slim drawer profile, thickness of only 14mm
- Simple assembly, easy set up, excellent durability
- Newly designed integrated mechanism, can bear upto 45kgs load
- Ultra smooth, silent & effortless closing
- Full extension for direct access & good view
- Available sizes 450mm, 500mm & 550mm



MIRROR SS



Product	Code	Size(mm)	MRP
Slim Box 4 - Inches	STB 4 (C) S.S 18"	450	4240
	STB 4 (C) S.S 20"	500	4240
	STB 4 (C) S.S 22"	550	5050
Slim Box 6 - Inches	STB 6 (C) S.S 18"	450	4740
	STB 6 (C) S.S 20"	500	4740
	STB 6 (C) S.S 22"	550	5550
Slim Box 8 - Inches	STB 8 (C) S.S 18"	450	5240
	STB 8 (C) S.S 20"	500	5240
	STB 8 (C) S.S 22"	550	6050

MATT SS



Product	Code	Size(mm)	MRP
Slim Box 4 - Inches	STB 4 (MATT) S.S 18"	450	4240
	STB 4 (MATT) S.S 20"	500	4240
	STB 4 (MATT) S.S 20"	550	5050
Slim Box 6 - Inches	STB 6 (MATT) S.S 18"	450	4740
	STB 6 (MATT) S.S 20"	500	4740
	STB 6 (MATT) S.S 20"	550	5550
Slim Box 8 - Inches	STB 8 (MATT) S.S 18"	450	5240
	STB 8 (MATT) S.S 20"	500	5240
	STB 8 (MATT) S.S 20"	550	6050

RICE GRAIN SS



Product	Code	Size(mm)	MRP
Slim Box 4 - Inches	STB 4 (D) S.S 18"	450	4240
	STB 4 (D) S.S 20"	500	4240
	STB 4 (D) S.S 20"	550	5050
Slim Box 6 - Inches	STB 6 (D) S.S 18"	450	4740
	STB 6 (D) S.S 20"	500	4740
	STB 6 (D) S.S 20"	550	5550
Slim Box 8 - Inches	STB 8 (D) S.S 18"	450	5240
	STB 8 (D) S.S 20"	500	5240
	STB 8 (D) S.S 20"	550	6050

Special Features

- Impressively slim drawer profile, thickness of only 14mm
- Simple assembly, easy set up, excellent durability
- Newly designed integrated mechanism, can bear upto 45kgs load
- Ultra smooth, silent & effortless closing

- Full extension for direct access & good view
- Available sizes 450mm, 500mm & 550mm



MS GREY



Product	Code	Size(mm)	MRP
Slim Box 4 - Inches	STB 4 (P) SLIM GREY 18"	450	3167
	STB 4 (P) SLIM GREY 20"	500	3167
	STB 4 (P) SLIM GREY 22"	550	3830
Slim Box 6 - Inches	STB 6 (P) SLIM GREY 18"	450	3667
	STB 6 (P) SLIM GREY 20"	500	3667
	STB 6 (P) SLIM GREY 22"	550	4330
Slim Box 8 - Inches	STB 8 (P) SLIM GREY 18"	450	4167
	STB 8 (P) SLIM GREY 20"	500	4167
	STB 8 (P) SLIM GREY 22"	550	4830

MS WHITE



Product	Code	Size(mm)	MRP
Slim Box 4 - Inches	STB 4 (P) SLIM WHITE 18"	450	3167
	STB 4 (P) SLIM WHITE 20"	500	3167
	STB 4 (P) SLIM WHITE 22"	550	3830
Slim Box 6 - Inches	STB 6 (P) SLIM WHITE 18"	450	3667
	STB 6 (P) SLIM WHITE 20"	500	3667
	STB 6 (P) SLIM WHITE 22"	550	4330
Slim Box 8 - Inches	STB 8 (P) SLIM WHITE 18"	450	4167
	STB 8 (P) SLIM WHITE 20"	500	4167
	STB 8 (P) SLIM WHITE 22"	550	4830

ALUMINIUM WOODEN



Product	Code	Size(mm)	MRP
Slim Box 4 - Inches	STB 4 (P) SLIM WOODEN 18"	450	4850
	STB 4 (P) SLIM WOODEN 20"	500	4850
	STB 4 (P) SLIM WOODEN 22"	550	5650
Slim Box 6 - Inches	STB 6 (P) SLIM WOODEN 18"	450	5700
	STB 6 (P) SLIM WOODEN 20"	500	5700
	STB 6 (P) SLIM WOODEN 22"	550	6500
Slim Box 8 - Inches	STB 8 (P) SLIM WOODEN 18"	450	6550
	STB 8 (P) SLIM WOODEN 20"	500	6550
	STB 8 (P) SLIM WOODEN 22"	550	7350

Special Features

- Impressively slim drawer profile, thickness of only 14mm
- Simple assembly, easy set up, excellent durability
- Newly designed integrated mechanism, can bear upto 45kgs load
- Ultra smooth, silent & effortless closing
- Full extension for direct access & good view
- Available sizes 450mm, 500mm & 550mm



ALUMINIUM BRUSH



Product	Code	Size(mm)	MRP
Slim Box 4 - Inches	STB 4 (P) SLIM BRUSH 18"	450	4850
	STB 4 (P) SLIM BRUSH 20"	500	4850
	STB 4 (P) SLIM BRUSH 22"	550	5650
Slim Box 6 - Inches	STB 6 (P) SLIM BRUSH 18"	450	5700
	STB 6 (P) SLIM BRUSH 20"	500	5700
	STB 6 (P) SLIM BRUSH 22"	550	6500
Slim Box 8 - Inches	STB 8 (P) SLIM BRUSH 18"	450	6550
	STB 8 (P) SLIM BRUSH 20"	500	6550
	STB 8 (P) SLIM BRUSH 22"	550	7350

ALUMINIUM BLACK



Product	Code	Size(mm)	MRP
Slim Box 4 - Inches	STB 4 (P) SLIM BLACK 18"	450	4850
	STB 4 (P) SLIM BLACK 20"	500	4850
	STB 4 (P) SLIM BLACK 22"	550	5650
Slim Box 6 - Inches	STB 6 (P) SLIM BLACK 18"	450	5700
	STB 6 (P) SLIM BLACK 20"	500	5700
	STB 6 (P) SLIM BLACK 22"	550	6500
Slim Box 8 - Inches	STB 8 (P) SLIM BLACK 18"	450	6550
	STB 8 (P) SLIM BLACK 20"	500	6550
	STB 8 (P) SLIM BLACK 22"	550	7350

ALUMINIUM MIRROR



Product	Code	Size(mm)	MRP
Slim Box 4 - Inches	STB 4 (P) SLIM MIRROR 18"	450	4850
	STB 4 (P) SLIM MIRROR 20"	500	4850
	STB 4 (P) SLIM MIRROR 22"	550	5650
Slim Box 6 - Inches	STB 6 (P) SLIM MIRROR 18"	450	5700
	STB 6 (P) SLIM MIRROR 20"	500	5700
	STB 6 (P) SLIM MIRROR 22"	550	6500
Slim Box 8 - Inches	STB 8 (P) SLIM MIRROR 18"	450	6550
	STB 8 (P) SLIM MIRROR 20"	500	6550
	STB 8 (P) SLIM MIRROR 22"	550	7350

Special Features

- Impressively slim drawer profile, thickness of only 14mm
- Simple assembly, easy set up, excellent durability
- Newly designed integrated mechanism, can bear upto 45kgs load
- Ultra smooth, silent & effortless closing

- Full extension for direct access & good view
- Available sizes 450mm, 500mm & 550mm



ALUMINIUM WOODEN



Product	Code	Size(mm)	MRP
E-Box Without Gallery	STB 4 (P) WOODEN 18"	450	4850
	STB 4 (P) WOODEN 20"	500	4850
	STB 4 (P) WOODEN 22"	550	5650
E-Box Single Gallery	STB 6 (P) WOODEN 18"	450	5700
	STB 6 (P) WOODEN 20"	500	5700
	STB 6 (P) WOODEN 22"	550	6500
E-Box Double Gallery	STB 8 (P) WOODEN 18"	450	6550
	STB 8 (P) WOODEN 20"	500	6550
	STB 8 (P) WOODEN 22"	550	7350

ALUMINIUM BLACK



Product	Code	Size(mm)	MRP
E-Box Without Gallery	STB 4 (P) BLACK 18"	450	4850
	STB 4 (P) BLACK 20"	500	4850
	STB 4 (P) BLACK 22"	550	5650
E-Box Single Gallery	STB 6 (P) BLACK 18"	450	5700
	STB 6 (P) BLACK 20"	500	5700
	STB 6 (P) BLACK 22"	550	6500
E-Box Double Gallery	STB 8 (P) BLACK 18"	450	6550
	STB 8 (P) BLACK 20"	500	6550
	STB 8 (P) BLACK 22"	550	7350

ALUMINIUM BRUSH



Product	Code	Size(mm)	MRP
E-Box Without Gallery	STB 4 (P) BRUSH 18"	450	4850
	STB 4 (P) BRUSH 20"	500	4850
	STB 4 (P) BRUSH 22"	550	5650
E-Box Single Gallery	STB 6 (P) BRUSH 18"	450	5700
	STB 6 (P) BRUSH 20"	500	5700
	STB 6 (P) BRUSH 22"	550	6500
E-Box Double Gallery	STB 8 (P) BRUSH 18"	450	6550
	STB 8 (P) BRUSH 20"	500	6550
	STB 8 (P) BRUSH 22"	550	7350

Special Features

- Impressively slim drawer profile, thickness of only 14mm
- Simple assembly, easy set up, excellent durability
- Newly designed integrated mechanism, can bear upto 45kgs load
- Ultra smooth, silent & effortless closing

- Full extension for direct access & good view
- Available sizes 450mm, 500mm & 550mm



ALUMINIUM MIRROR



Product	Code	Size(mm)	MRP
E-Box Without Gallery	STB 4 (P) MIRROR 18"	450	4850
	STB 4 (P) MIRROR 20"	500	4850
	STB 4 (P) MIRROR 22"	550	5650
E-Box Single Gallery	STB 6 (P) MIRROR 18"	450	5700
	STB 6 (P) MIRROR 20"	500	5700
	STB 6 (P) MIRROR 22"	550	6500
E-Box Double Gallery	STB 8 (P) MIRROR 18"	450	6550
	STB 8 (P) MIRROR 20"	500	6550
	STB 8 (P) MIRROR 22"	550	7350

ALUMINIUM WHITE



Product	Code	Size(mm)	MRP
E-Box Without Gallery	STB 4 (P) WHITE 18"	450	4850
	STB 4 (P) WHITE 20"	500	4850
	STB 4 (P) WHITE 22"	550	5650
E-Box Single Gallery	STB 6 (P) WHITE 18"	450	5700
	STB 6 (P) WHITE 20"	500	5700
	STB 6 (P) WHITE 22"	550	6500
E-Box Double Gallery	STB 8 (P) WHITE 18"	450	6550
	STB 8 (P) WHITE 20"	500	6550
	STB 8 (P) WHITE 22"	550	7350

ALUMINIUM GREY



Product	Code	Size(mm)	MRP
E-Box Without Gallery	STB 4 (P) GREY 16"	450	4850
	STB 4 (P) GREY 20"	500	4850
	STB 4 (P) GREY 22"	550	5650
E-Box Single Gallery	STB 6 (P) GREY 18"	450	5700
	STB 6 (P) GREY 20"	500	5700
	STB 6 (P) GREY 22"	550	6500
E-Box Double Gallery	STB 8 (P) GREY 18"	450	6550
	STB 8 (P) GREY 20"	500	6550
	STB 8 (P) GREY 22"	550	7350

Special Features

- Impressively slim drawer profile, thickness of only 14mm
- Simple assembly, easy set up, excellent durability
- Newly designed integrated mechanism, can bear upto 45kgs load
- Ultra smooth, silent & effortless closing

- Full extension for direct access & good view
- Available sizes 450mm, 500mm & 550mm



SS PVD BASKET WITH 45KG SOFTCLOSE QUADRO

Innovation, Elegance, Quality...!

PVD SS ROSE GOLD (WITH QUADRO SLIDE)

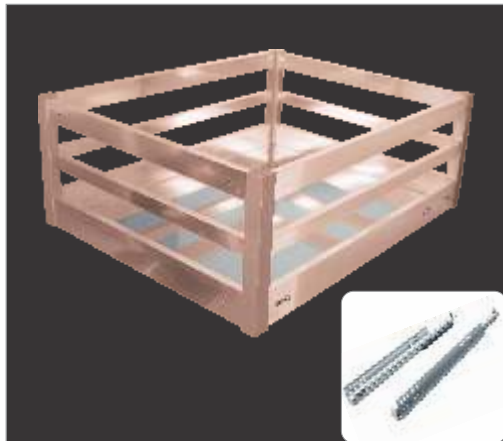

Code	Size(inches)	MRP	Code	Size(inches)	MRP
RPB 15 20 4	15x20x4	5860	RPB 15 20 8	15x20x8	8268
RPB 17 20 4	17x20x4	6640	RPB 17 20 8	17x20x8	9374
RPB 19 20 4	19x20x4	7469	RPB 19 20 8	19x20x8	10422
RPB 21 20 4	21x20x4	7906	RPB 21 20 8	21x20x8	11164
RPB 24 20 4	24x20x4	9035	RPB 24 20 8	24x20x8	12759
RPB 28 20 4	28x20x4	10748	RPB 28 20 8	28x20x8	15197
RPB 32 20 4	32x20x4	12298	RPB 32 20 8	32x20x8	17364
RPB 15 20 6	15x20x6	6895	RCT 15 20 4	15x20x4	8408
RPB 17 20 6	17x20x6	7813	RCT 17 20 4	17x20x4	9526
RPB 19 20 6	19x20x6	8786	RCT 19 20 4	19x20x4	10722
RPB 21 20 6	21x20x6	9300	RCT 21 20 4	21x20x4	11352
RPB 24 20 6	24x20x6	10628	RCT 24 20 4	24x20x4	12973
RPB 28 20 6	28x20x6	12654			
RPB 32 20 6	32x20x6	14666			

PVD SS GOLD (WITH QUADRO SLIDE)



Code	Size(inches)	MRP	Code	Size(inches)	MRP
YPB 15 20 4	15x20x4	5860	YPB 15 20 8	15x20x8	8268
YPB 17 20 4	17x20x4	6640	YPB 17 20 8	17x20x8	9374
YPB 19 20 4	19x20x4	7469	YPB 19 20 8	19x20x8	10422
YPB 21 20 4	21x20x4	7906	YPB 21 20 8	21x20x8	11164
YPB 24 20 4	24x20x4	9035	YPB 24 20 8	24x20x8	12759
YPB 28 20 4	28x20x4	10748	YPB 28 20 8	28x20x8	15197
YPB 32 20 4	32x20x4	12298	YPB 32 20 8	32x20x8	17364
YPB 15 20 6	15x20x6	6895	YCT 15 20 4	15x20x4	8408
YPB 17 20 6	17x20x6	7813	YCT 17 20 4	17x20x4	9526
YPB 19 20 6	19x20x6	8786	YCT 19 20 4	19x20x4	10722
YPB 21 20 6	21x20x6	9300	YCT 21 20 4	21x20x4	11352
YPB 24 20 6	24x20x6	10628	YCT 24 20 4	24x20x4	12973
YPB 28 20 6	28x20x6	12664			
YPB 32 20 6	32x20x6	14666			

PVD SS TITANIUM (WITH QUADRO SLIDE)



Code	Size(inches)	MRP	Code	Size(inches)	MRP
ZPB 15 20 4	15x20x4	5860	ZPB 15 20 8	15x20x8	8268
ZPB 17 20 4	17x20x4	6640	ZPB 17 20 8	17x20x8	9374
ZPB 19 20 4	19x20x4	7469	ZPB 19 20 8	19x20x8	10422
ZPB 21 20 4	21x20x4	7906	ZPB 21 20 8	21x20x8	11164
ZPB 24 20 4	24x20x4	9035	ZPB 24 20 8	24x20x8	12759
ZPB 28 20 4	28x20x4	10748	ZPB 28 20 8	28x20x8	15197
ZPB 32 20 4	32x20x4	12298	ZPB 32 20 8	32x20x8	17364
ZPB 15 20 6	15x20x6	6895	ZCT 15 20 4	15x20x4	8408
ZPB 17 20 6	17x20x6	7813	ZCT 17 20 4	17x20x4	9526
ZPB 19 20 6	19x20x6	8786	ZCT 19 20 4	19x20x4	10722
ZPB 21 20 6	21x20x6	9300	ZCT 21 20 4	21x20x4	11352
ZPB 24 20 6	24x20x6	10628	ZCT 24 20 4	24x20x4	12973
ZPB 28 20 6	28x20x6	12664			
ZPB 32 20 6	32x20x6	14666			

Product Features

- The side grill is in luxurious three finish of stainless steel
- Anti finger print surface
- Provides optimal use of space & excellent access from both sides
- Partitions for bowl, cup & saucer, plate & thali also available for these baskets
- The specially developed finish is anti corrosive & avoids the metal parts from rusting under harsh conditions
- The special grade steel is resistant to house hold cleaners
- The basket are compatible with telescopic channels of all brands
- Quadro channel compatibility with Sterling quadro slides



ALUMINIUM GREY (WITH QUADRO SLIDE)



Code	Size(inches)	MRP	Code	Size(inches)	MRP
GPB 15 20 4	15x20x4	4186	GPB 15 20 8	15x20x8	5906
GPB 17 20 4	17x20x4	4742	GPB 17 20 8	17x20x8	6696
GPB 19 20 4	19x20x4	5335	GPB 19 20 8	19x20x8	7445
GPB 21 20 4	21x20x4	5647	GPB 21 20 8	21x20x8	7974
GPB 24 20 4	24x20x4	6588	GPB 24 20 8	24x20x8	9305
GPB 28 20 4	28x20x4	7686	GPB 28 20 8	28x20x8	10855
GPB 32 20 4	32x20x4	8784	GPB 32 20 8	32x20x8	12403
GPB 15 20 6	15x20x6	4925	GCT 15 20 4	15x20x4	6006
GPB 17 20 6	17x20x6	5581	GCT 17 20 4	17x20x4	6804
GPB 19 20 6	19x20x6	6276	GCT 19 20 4	19x20x4	7658
GPB 21 20 6	21x20x6	6643	GCT 21 20 4	21x20x4	8108
GPB 24 20 6	24x20x6	7753	GCT 24 20 4	24x20x4	9266
GPB 28 20 6	28x20x6	9046			
GPB 32 20 6	32x20x6	10476			

ALUMINIUM MIRROR (WITH QUADRO SLIDE)

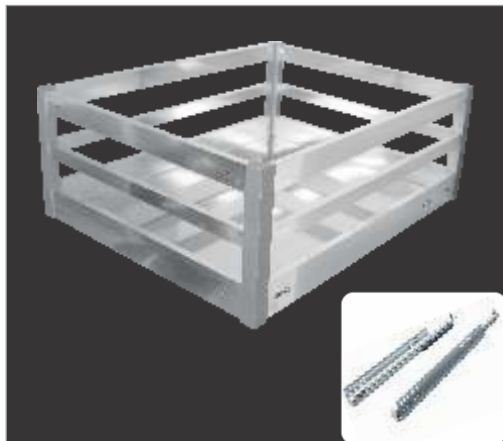

Code	Size(inches)	MRP	Code	Size(inches)	MRP
GPB C 15 20 4	15x20x4	4186	GPB C 15 20 8	15x20x8	5906
GPB C 17 20 4	17x20x4	4742	GPB C 17 20 8	17x20x8	6696
GPB C 19 20 4	19x20x4	5335	GPB C 19 20 8	19x20x8	7445
GPB C 21 20 4	21x20x4	5647	GPB C 21 20 8	21x20x8	7974
GPB C 24 20 4	24x20x4	6588	GPB C 24 20 8	24x20x8	9305
GPB C 28 20 4	28x20x4	7686	GPB C 28 20 8	28x20x8	10855
GPB C 32 20 4	32x20x4	8784	GPB C 32 20 8	32x20x8	12403
GPB C 15 20 6	15x20x6	4925	GCT C 15 20 4	15x20x4	6006
GPB C 17 20 6	17x20x6	5581	GCT C 17 20 4	17x20x4	6804
GPB C 19 20 6	19x20x6	6276	GCT C 19 20 4	19x20x4	7658
GPB C 21 20 6	21x20x6	6643	GCT C 21 20 4	21x20x4	8108
GPB C 24 20 6	24x20x6	7753	GCT C 24 20 4	24x20x4	9266
GPB C 28 20 6	28x20x6	9046			
GPB C 32 20 6	32x20x6	10476			

ALUMINIUM WOODEN (WITH QUADRO SLIDE)



Code	Size(inches)	MRP	Code	Size(inches)	MRP
TPB 15 20 4	15x20x4	4186	TPB 15 20 8	15x20x8	5906
TPB 17 20 4	17x20x4	4742	TPB 17 20 8	17x20x8	6696
TPB 19 20 4	19x20x4	5335	TPB 19 20 8	19x20x8	7445
TPB 21 20 4	21x20x4	5647	TPB 21 20 8	21x20x8	7974
TPB 24 20 4	24x20x4	6588	TPB 24 20 8	24x20x8	9305
TPB 28 20 4	28x20x4	7686	TPB 28 20 8	28x20x8	10855
TPB 32 20 4	32x20x4	8784	TPB 32 20 8	32x20x8	12403
TPB 15 20 6	15x20x6	4925	TCT 15 20 4	15x20x4	6006
TPB 17 20 6	17x20x6	5581	TCT 17 20 4	17x20x4	6804
TPB 19 20 6	19x20x6	6276	TCT 19 20 4	19x20x4	7658
TPB 21 20 6	21x20x6	6643	TCT 21 20 4	21x20x4	8108
TPB 24 20 6	24x20x6	7753	TCT 24 20 4	24x20x4	9266
TPB 28 20 6	28x20x6	9046			
TPB 32 20 6	32x20x6	10476			

Special Features

- Impressively slim drawer profile, thickness of only 14mm
- Simple assembly, easy set up, excellent durability
- Newly designed integrated mechanism, can bear upto 45kgs load
- Ultra smooth, silent & effortless closing
- Full extension for direct access & good view
- Available sizes 450mm, 500mm & 550mm



BLACK (WITH QUADRO SLIDE)



Code	Size(inches)	MRP	Code	Size(inches)	MRP
GPB 15 20 4	15x20x4	4186	GPB 15 20 8	15x20x8	5906
GPB 17 20 4	17x20x4	4742	GPB 17 20 8	17x20x8	6696
GPB 19 20 4	19x20x4	5335	GPB 19 20 8	19x20x8	7445
GPB 21 20 4	21x20x4	5647	GPB 21 20 8	21x20x8	7974
GPB 24 20 4	24x20x4	6588	GPB 24 20 8	24x20x8	9305
GPB 28 20 4	28x20x4	7686	GPB 28 20 8	28x20x8	10855
GPB 32 20 4	32x20x4	8784	GPB 32 20 8	32x20x8	12403
GPB 15 20 6	15x20x6	4825	GCT 15 20 4	15x20x4	6006
GPB 17 20 6	17x20x6	5581	GCT 17 20 4	17x20x4	6804
GPB 19 20 6	19x20x6	6276	GCT 19 20 4	19x20x4	7658
GPB 21 20 6	21x20x6	6643	GCT 21 20 4	21x20x4	8108
GPB 24 20 6	24x20x6	7753	GCT 24 20 4	24x20x4	9266
GPB 28 20 6	28x20x6	9046			
GPB 32 20 6	32x20x6	10476			

WHITE (WITH QUADRO SLIDE)



Code	Size(inches)	MRP	Code	Size(inches)	MRP
GPB 15 20 4	15x20x4	4186	GPB 15 20 8	15x20x8	5906
GPB 17 20 4	17x20x4	4742	GPB 17 20 8	17x20x8	6696
GPB 19 20 4	19x20x4	5335	GPB 19 20 8	19x20x8	7445
GPB 21 20 4	21x20x4	5647	GPB 21 20 8	21x20x8	7974
GPB 24 20 4	24x20x4	6588	GPB 24 20 8	24x20x8	9305
GPB 28 20 4	28x20x4	7686	GPB 28 20 8	28x20x8	10855
GPB 32 20 4	32x20x4	8784	GPB 32 20 8	32x20x8	12403
GPB 15 20 6	15x20x6	4825	GCT 15 20 4	15x20x4	6006
GPB 17 20 6	17x20x6	5581	GCT 17 20 4	17x20x4	6804
GPB 19 20 6	19x20x6	6276	GCT 19 20 4	19x20x4	7658
GPB 21 20 6	21x20x6	6643	GCT 21 20 4	21x20x4	8108
GPB 24 20 6	24x20x6	7753	GCT 24 20 4	24x20x4	9266
GPB 28 20 6	28x20x6	9046			
GPB 32 20 6	32x20x6	10476			

SATIN BRUSH (WITH QUADRO SLIDE)



Code	Size(inches)	MRP	Code	Size(inches)	MRP
GPB 15 20 4	15x20x4	4186	GPB 15 20 8	15x20x8	5906
GPB 17 20 4	17x20x4	4742	GPB 17 20 8	17x20x8	6696
GPB 19 20 4	19x20x4	5335	GPB 19 20 8	19x20x8	7445
GPB 21 20 4	21x20x4	5647	GPB 21 20 8	21x20x8	7974
GPB 24 20 4	24x20x4	6588	GPB 24 20 8	24x20x8	9305
GPB 28 20 4	28x20x4	7686	GPB 28 20 8	28x20x8	10855
GPB 32 20 4	32x20x4	8784	GPB 32 20 8	32x20x8	12403
GPB 15 20 6	15x20x6	4825	GCT 15 20 4	15x20x4	6006
GPB 17 20 6	17x20x6	5581	GCT 17 20 4	17x20x4	6804
GPB 19 20 6	19x20x6	6276	GCT 19 20 4	19x20x4	7658
GPB 21 20 6	21x20x6	6643	GCT 21 20 4	21x20x4	8108
GPB 24 20 6	24x20x6	7753	GCT 24 20 4	24x20x4	9266
GPB 28 20 6	28x20x6	9046			
GPB 32 20 6	32x20x6	10476			

Product Features

- The side grill is in luxurious three finish of stainless steel
- Anti finger print surface
- Provides optimal use of space & excellent access from both sides
- Partitions for bowl, cup & saucer, plate & thali also available for these baskets
- The specially developed finish is anti corrosive & avoids the metal parts from rusting under harsh conditions
- The special grade steel is resistant to house hold cleaners
- The basket are compatible with telescopic channels of all brands
- Quadro channel compatibility with Sterling quadro slides



CUP & SAUCER PARTITION



Code - ETCSPA MRP - 1800/-



Code - TCBPA MRP - 900/-



Code - ETCSPA (GREY) MRP - 1900/-



Code - TCBPA (GREY) MRP - 1000/-

PLATE PARTITION



Code - ETPTPA MRP - 1800/-



Code - TPTPA MRP - 900/-



Code - ETPTPA (GREY) MRP - 1900/-



Code - TPTPA (GREY) MRP - 1000/-

THALI PARTITION



Code - ETTHPA MRP - 2000/-



Code - TTHPA MRP - 950/-



Code - ETTHPA (GREY) MRP - 2100/-



Code - TTHPA (GREY) MRP - 1050/-



GLASS BASKET WITH 45KG SOFTCLOSE QUADRO



Code	Size(in mm)	MRP
CPB-15 20 6	380 x 450	7500
CPB-21 20 6	530 x 600	8500
CPB-33 20 6	830 x 900	10000

GLASS BOTTLE PULLOUT (GREY BASE)



Code	Size(in mm)	MRP
CBPO-150/2	100 x 150	6850
CBPO-200/2	150 x 200	7334
CBPO-250/2	200 x 250	8000
CBPO-300/2	250 x 300	8668

GLASS BOTTLE PULLOUT (SS BASE)

Code	Size(in mm)	MRP
CBPO-150/2	100 x 150	7535
CBPO-200/2	150 x 200	8214
CBPO-250/2	200 x 250	8800
CBPO-300/2	250 x 300	9535

GLASS MAGIC CORNER (GREY BASE)



Code	Size(in mm)	MRP
CULGC (Universal)	900 - 1000	25000

GLASS MAGIC CORNER (SS BASE)

Code	Size(in mm)	MRP
CULGC (Universal)	900 - 1000	30000

GLASS SIDE MOUNTING PULLOUT WITHOUT BEEDING



Code	Size(in mm)	MRP(GREY BASE)	MRP(SS BASE)
CSP0-200/2	200	7334	8214
CSP0-250/2	200	8000	8800
CSP0-300/2	300	8668	9535

GLASS SIDE MOUNTING PULLOUT WITH BEEDING

Code	Size(in mm)	MRP(GREY BASE)	MRP(SS BASE)
CSP0-200/2	200	8200	9020
CSP0-250/2	200	8800	9680
CSP0-300/2	300	9600	10560





SPACE LADDER - WHITE

Code	Size(mm)	Drawer	MRP
EO-417B-ST-600-5-W	600	5	46500
EO-417D-ST-900-5-W	900	5	65000

SPACE LADDER - GREY

Code	Size(mm)	Drawer	MRP
EO-417F-ST-600-5-G	600	5	46500
EO-417H-ST-900-5-G	900	5	65000

Product Features

- Drawer sizes - 1 x 86mm and 4 x 182mm with glass
- Pull out with soft closing. Load capacity of 35kgs per drawer
- Provides optimal use of space & excellent access from three sides
- Designed for high quality anti rust functions
- All 4 big drawers have glass on 3 sides
- Available in 6 colors



GLASS PANTRY



GLASS PANTRY

Product	Code	Product Dimension(mm)	MRP
8-Baskets/450	SC CMPN 16 450 MM	385x485XH1200-1450	23000
8-Baskets/600	SC CMPN 21 600 MM	535x485XH1200-1450	25000
12-Baskets/450	SC CPN 16 450 MM	385x485XH1940-2150	25000
12-Baskets/600	SC CPN 21 600 MM	535x485XH1940-2150	28334

Special Features

- The side rail is of tempered glass with gasket
- The base of the basket is MDF sheet
- Frame & baskets have height adjustment
- Single pullout unit with option of 8 or 12 baskets
- Ergonomically designed integrated mechanism automatically slides out the baskets on opening of the cabinet, making way for optimum reach
- Smooth opening, soft closing, load capacity
- Left hand & right hand compatible
- Opening till 110 degree
- Available width 450mm, 600mm



GLASS PANTRY WITH BEEDING

Product	Code	Product Dimension(mm)	MRP
8-Baskets/450	SC CMPN 16 450 MM	385x485XH1200-1450	30000
8-Baskets/600	SC CMPN 21 600 MM	535x485XH1200-1450	31667
12-Baskets/450	SC CPN 16 450 MM	385x485XH1940-2150	35000
12-Baskets/600	SC CPN 21 600 MM	535x485XH1940-2150	38334

Special Features

- The side rail is of tempered glass with beeding
- The base of the basket is MDF grey sheet
- Frame & baskets have height adjustment
- Single pullout unit with option of 8 or 12 baskets
- Ergonomically designed integrated mechanism automatically slides out the baskets on opening of the cabinet, making way for optimum reach
- Smooth opening, soft closing, load capacity
- Left hand & right hand compatible
- Opening till 110 degree
- Available width 450mm, 600mm

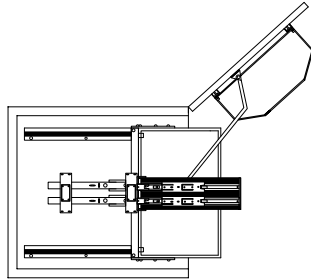

SATIN FINISH GREY BASE PANTRY

Product	Code	Product Dimension(mm)	MRP
8-Baskets/450	SC GMPN 16 450 MM	385x485XH1200-1450	23000
8-Baskets/600	SC GMPN 21 600 MM	535x485XH1200-1450	25000
12-Baskets/450	SC GPN 16 450 MM	385x485XH1940-2150	25000
12-Baskets/600	SC GPN 21 600 MM	535x485XH1940-2150	28334

Special Features

- The side rail is in satin finish stainless steel
- The basket base is of stainless steel sheet
- Frame & baskets have height adjustment
- Single pullout unit with option of 8 or 12 baskets
- Ergonomically designed integrated mechanism automatically slides out the baskets on opening of the cabinet, making way for optimum reach
- Smooth opening, soft closing, load capacity
- Left hand & right hand compatible
- Opening till 110 degree
- Available width 450mm, 600mm

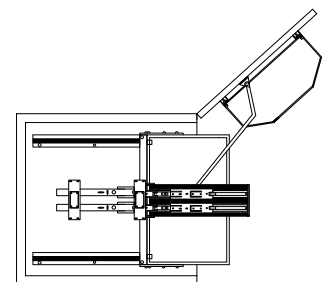

SATIN ALUMINIUM PANTRY WITH SS BASE

Product	Code	Product Dimension(mm)	MRP
8-Baskets/450	EO-401A-PU-450-8-S	385x485XH1200-1450	33000
8-Baskets/600	EO-401B-PU-600-8-S	535x485XH1200-1450	36500
12-Baskets/450	EO-401C-PU-450-12-S	385x485XH1940-2150	39800
12-Baskets/600	EO-401D-PU-600-12-S	535x485XH1940-2150	43000

Special Features

- The side rail is in satin brush finish stainless steel
- The basket base is of stainless steel sheet
- Frame & baskets have height adjustment
- Single pullout unit with option of 8 or 12 baskets
- Ergonomically designed integrated mechanism automatically slides out the baskets on opening of the cabinet, making way for optimum reach
- Smooth opening, soft closing, load capacity
- Left hand & right hand compatible
- Opening till 110 degree
- Available width 450mm, 600mm

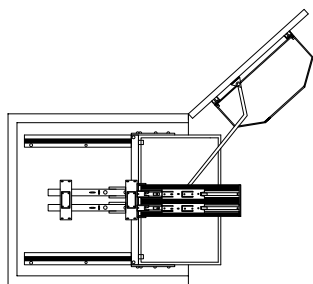
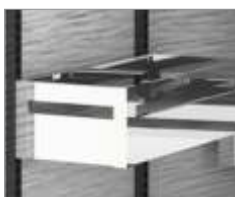

GLASS SATIN ALUMINIUM WITH SS BASED

Product	Code	Product Dimension(mm)	MRP
8-Baskets/450	EO-405A-PU-450-8-S	385x485XH1200-1450	33000
8-Baskets/600	EO-405B-PU-600-8-S	535x485XH1200-1450	36500
12-Baskets/450	EO-405C-PU-450-12-S	385x485XH1940-2150	39800
12-Baskets/600	EO-405D-PU-600-12-S	535x485XH1940-2150	43000

Special Features

- The side rail of glass
- The basket base is wooden
- Frame & baskets have height adjustment
- Single pullout unit with option of 8 or 12 baskets
- Ergonomically designed integrated mechanism automatically slides out the baskets on opening of the cabinet, making way for optimum reach
- Smooth opening, soft closing, load capacity
- Left hand & right hand compatible
- Opening till 110 degree
- Available width 450mm,600mm

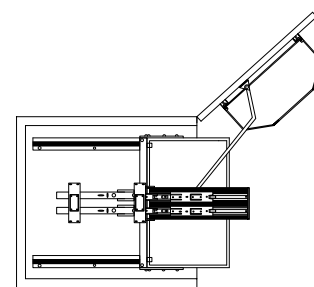

SATIN MIRROR PANTRY WITH SS BASE

Product	Code	Product Dimension(mm)	MRP
8-Baskets/450	SC GMPN C 16 450 MM	385x485XH1200-1450	33000
8-Baskets/600	SC GMPN C 21 600 MM	535x485XH1200-1450	36500
12-Baskets/450	SC GPN C 16 450 MM	385x485XH1940-2150	39800
12-Baskets/600	SC GPN C 21 600 MM	535x485XH1940-2150	43000

Special Features

- The side rail is in satin mirror finish aluminium
- The base of the basket is stainless steel.
- Frame & baskets have height adjustment
- Single pullout unit with option of 8 or 12 baskets
- Ergonomically designed integrated mechanism automatically slides out the baskets on opening of the cabinet, making way for optimum reach
- Smooth opening, soft closing, load capacity
- Left hand & right hand compatible
- Opening till 110 degree
- The Sterling series pantry unit is available in 7 luxurious colours
- Available width 450mm,600mm

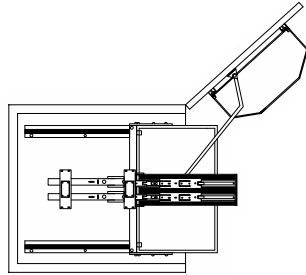

SATIN MIRROR GLASS PANTRY

Product	Code	Product Dimension(mm)	MRP
8-Baskets/450	SC CMPN (C) 16 450 MM	385x485XH1200-1450	33000
8-Baskets/600	SC CMPN (C) 21 600 MM	535x485XH1200-1450	36500
12-Baskets/450	SC CPN (C) 16 450 MM	385x485XH1940-2150	39800
12-Baskets/600	SC CPN (C) 21 600 MM	535x485XH1940-2150	43000

Special Features

- The side rail is in satin mirror finish of aluminium with glass
- Frame & baskets have height adjustment
- Single pullout unit with option of 8 or 12 baskets
- Ergonomically designed integrated mechanism automatically slides out the baskets on opening of the cabinet, making way for optimum reach
- Smooth opening, soft closing, load capacity
- Left hand & right hand compatible
- Opening till 110 degree
- The Sterling series pantry unit is available in 7 luxurious colours
- Available width 450mm,600mm

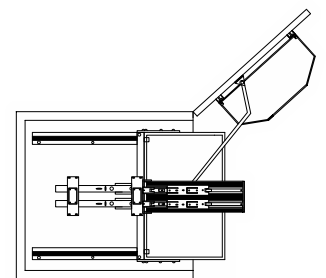

PVD GOLD PANTRY WITH SS BASE

Product	Code	Product Dimension(mm)	MRP
8-Baskets/450	SC YMPN C 16 450 MM	385x485XH1200-1450	50500
8-Baskets/600	SC YMPN C 21 600 MM	535x485XH1200-1450	53500
12-Baskets/450	SC YPN C 16 450 MM	385x485XH1940-2150	57500
12-Baskets/600	SC YPN C 21 600 MM	535x485XH1940-2150	60500

Special Features

- The side rail is in gold finish stainless steel
- The base of the basket is stainless steel.
- Frame & baskets have height adjustment
- Single pullout unit with option of 8 or 12 baskets
- Ergonomically designed integrated mechanism automatically slides out the baskets on opening of the cabinet, making way for optimum reach
- Smooth opening , soft closing, load capacity-100kgs
- Left hand & right hand compatible
- Opening till 110 degree
- The Sterling series Pantry Unit comes in 7 Luxurious Colours
- Available width 450mm,600mm

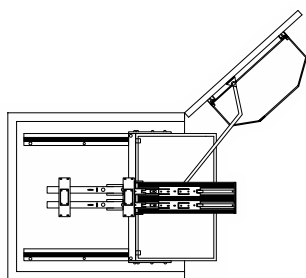

PVD GOLD GLASS PANTRY WITH SS BASE

Product	Code	Product Dimension(mm)	MRP
8-Baskets/450	SC CYMPN 16 450 MM	385x485XH1200-1450	50500
8-Baskets/600	SC CYMPN 21 600 MM	535x485XH1200-1450	53500
12-Baskets/450	SC CYPN 16 450 MM	385x485XH1940-2150	57500
12-Baskets/600	SC CYPN 21 600 MM	535x485XH1940-2150	60500

Special Features

- The side rail is in gold finish of stainless steel with glass
- The base of the basket is stainless steel.
- Frame & baskets have height adjustment
- Single pullout unit with option of 8 or 12 baskets
- Ergonomically designed integrated mechanism automatically slides out the baskets on opening of the cabinet, making way for optimum reach
- Smooth opening , soft closing, load capacity-100kgs
- Left hand & right hand compatible
- Opening till 110 degree
- The Sterling series Pantry Unit comes in 7 Luxurious Colours
- Available width 450mm,600mm

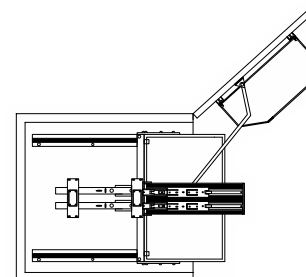

PVD ROSE GOLD PANTRY WITH SS BASE)

Product	Code	Product Dimension(mm)	MRP
8-Baskets/450	SC RMPN C 16 450 MM	385x485XH1200-1450	50500
8-Baskets/600	SC RMPN C 21 600 MM	535x485XH1200-1450	53500
12-Baskets/450	SC RPN C 16 450 MM	385x485XH1940-2150	57500
12-Baskets/600	SC RPN C 21 600 MM	535x485XH1940-2150	60500

Special Features

- The side rail is in rose gold finish stainless steel
- The base of the basket is stainless steel.
- Frame & baskets have height adjustment
- Single pullout unit with option of 8 or 12 baskets
- Ergonomically designed integrated mechanism automatically slides out the baskets on opening of the cabinet, making way for optimum reach
- Smooth opening, soft closing, load capacity-100kgs
- Left hand & right hand compatible
- Opening till 110 degree
- The Sterling series pantry unit comes in 7 luxurious colours
- Available width 450mm, 600mm

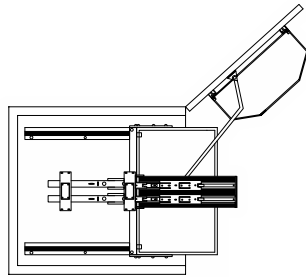
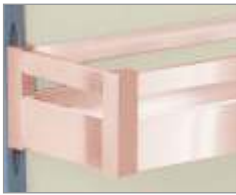

PVD ROSE GOLD GLASS PANTRY WITH SS BASE)

Product	Code	Product Dimension(mm)	MRP
8-Baskets/450	SC CMPN (R) 16 450 MM	385x485XH1200-1450	50500
8-Baskets/600	SC CMPN (R) 21 600 MM	535x485XH1200-1450	53500
12-Baskets/450	SC CPN (R) 16 450 MM	385x485XH1940-2150	57500
12-Baskets/600	SC CPN (R) 21 600 MM	535x485XH1940-2150	60500

Special Features

- The side rail is in rose gold finish of stainless steel with glass
- The base of the basket is stainless steel.
- Frame & baskets have height adjustment
- Single pullout unit with option of 8 or 12 baskets
- Ergonomically designed integrated mechanism automatically slides out the baskets on opening of the cabinet, making way for optimum reach
- Smooth opening, soft closing, load capacity-100kgs
- Left hand & right hand compatible
- Opening till 110 degree
- The Sterling series pantry unit comes in 7 luxurious colours
- Available width 450mm, 600mm

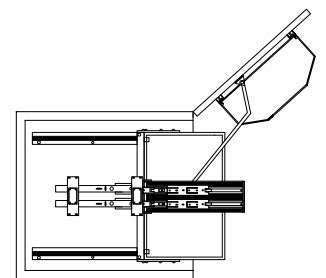

PVD TITANIUM PANTRY WITH SS BASE)

Product	Code	Product Dimension(mm)	MRP
8-Baskets/450	SC ZMPN 16 450 MM	385x485XH1200-1450	50500
8-Baskets/600	SC ZMPN 21 600 MM	535x485XH1200-1450	53500
12-Baskets/450	SC ZPN 16 450 MM	385x485XH1940-2150	57500
12-Baskets/600	SC ZPN 21 600 MM	535x485XH1940-2150	60500

Special Features

- The side rail is in black aluminium
- The base of the basket is stainless steel.
- Frame & baskets have height adjustment
- Single pullout unit with option of 8 or 12 baskets
- Ergonomically designed integrated mechanism automatically slides out the baskets on opening of the cabinet, making way for optimum reach
- Smooth opening, soft closing, load capacity-100kgs
- Left hand & right hand compatible
- Opening till 110 degree
- The Sterling series pantry unit comes in 7 luxurious colours
- Available width 450mm,600mm

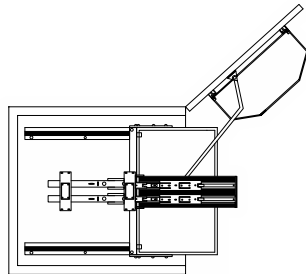

PVD TITANIUM GLASS PANTRY WITH SS BASE

Product	Code	Product Dimension(mm)	MRP
8-Baskets/450	SC CMPN (Z) 16 450 MM	385x485XH1200-1450	50500
8-Baskets/600	SC CMPN (Z) 21 600 MM	535x485XH1200-1450	53500
12-Baskets/450	SC CPN (Z) 16 450 MM	385x485XH1940-2150	57500
12-Baskets/600	SC CPN (Z) 21 600 MM	535x485XH1940-2150	60500

Special Features

- The side rail is in black aluminium with glass
- The base of the basket is stainless steel.
- Frame & baskets have height adjustment
- Single pullout unit with option of 8 or 12 baskets
- Ergonomically designed integrated mechanism automatically slides out the baskets on opening of the cabinet, making way for optimum reach
- Smooth opening, soft closing, load capacity-100kgs
- Left hand & right hand compatible
- Opening till 110 degree
- The Sterling series pantry unit comes in 7 luxurious colours
- Available width 450mm,600mm

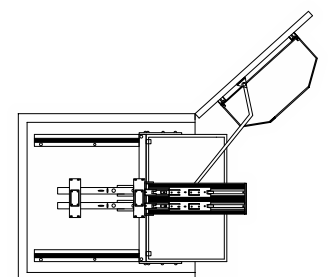

ALUMINUM WOODEN PANTRY WITH SS BASE

Product	Code	Product Dimension(mm)	MRP
8-Baskets/450	SC TMPN 16 450 MM	385x485XH1200-1450	33000
8-Baskets/600	SC TMPN 21 600 MM	535x485XH1200-1450	36500
12-Baskets/450	SC TPN 16 450 MM	385x485XH1940-2150	39800
12-Baskets/600	SC TPN 21 600 MM	535x485XH1940-2150	43000

Special Features

- The side rail is in wooden finish aluminium
- The base of the basket is stainless steel.
- Frame & baskets have height adjustment
- Single pullout unit with option of 8 or 12 baskets
- Ergonomically designed integrated mechanism automatically slides out the baskets on opening of the cabinet, making way for optimum reach
- Smooth opening, soft closing, load capacity-100kgs
- Left hand & right hand compatible
- Opening till 110 degree
- The Sterling series pantry unit comes in 7 luxurious colours
- Available width 450mm, 600mm

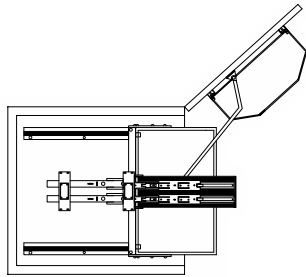

ALUMINUM WOODEN GLASS PANTRY WITH SS BASE

Product	Code	Product Dimension(mm)	MRP
8-Baskets/450	SC CTMPN 16 450 MM	385x485XH1200-1450	33000
8-Baskets/600	SC CTMPN 21 600 MM	535x485XH1200-1450	36500
12-Baskets/450	SC CTPN 16 450 MM	385x485XH1940-2150	39800
12-Baskets/600	SC CTPN 21 600 MM	535x485XH1940-2150	43000

Special Features

- The side rail is in wooden finish of aluminium with glass
- The base of the basket is stainless steel.
- Frame & baskets have height adjustment
- Single pullout unit with option of 8 or 12 baskets
- Ergonomically designed integrated mechanism automatically slides out the baskets on opening of the cabinet, making way for optimum reach
- Smooth opening, soft closing, load capacity-100kgs
- Left hand & right hand compatible
- Opening till 110 degree
- The Sterling series pantry unit comes in 7 luxurious colours
- Available width 450mm, 600mm

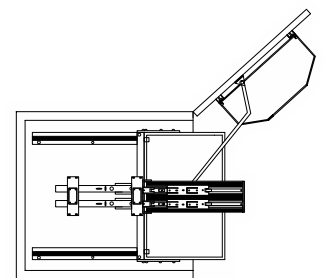

ALUMINUM WOODEN + BLACK PANTRY WITH SS BASE

Product	Code	Product Dimension(mm)	MRP
8-Baskets/450	SC ZTMPN 16 450 MM	385x485XH1200-1450	50500
8-Baskets/600	SC ZTMPN 21 600 MM	535x485XH1200-1450	53500
12-Baskets/450	SC ZTPN 16 450 MM	385x485XH1940-2150	57500
12-Baskets/600	SC ZTPN 21 600 MM	535x485XH1940-2150	60500

Special Features

- The side rail is fusion of wood and black finish
- The base of the basket is stainless steel.
- Frame & baskets have height adjustment
- Single pullout unit with option of 8 or 12 baskets
- Ergonomically designed integrated mechanism automatically slides out the baskets on opening of the cabinet, making way for optimum reach
- Smooth opening, soft closing, load capacity-100kgs
- Left hand & right hand compatible
- Opening till 110 degree
- The Sterling series pantry unit comes in 7 luxurious colours
- Available width 450mm, 600mm

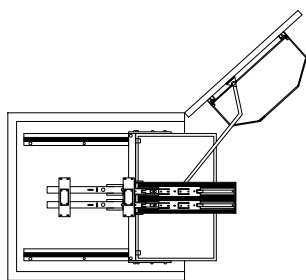

ALUMINUM WOODEN + GREY PANTRY WITH SS BASE

Product	Code	Product Dimension(mm)	MRP
8-Baskets/450	SC CTMPN 16 450 MM	385x485XH1200-1450	50500
8-Baskets/600	SC CTMPN 21 600 MM	535x485XH1200-1450	53500
12-Baskets/450	SC CTPN 16 450 MM	385x485XH1940-2150	57500
12-Baskets/600	SC CTPN 21 600 MM	535x485XH1940-2150	60500

Special Features

- The side rail is fusion of wood and grey finish
- The base of the basket is stainless steel.
- Frame & baskets have height adjustment
- Single pullout unit with option of 8 or 12 baskets
- Ergonomically designed integrated mechanism automatically slides out the baskets on opening of the cabinet, making way for optimum reach
- Smooth opening, soft closing, load capacity-100kgs
- Left hand & right hand compatible
- Opening till 110 degree
- The Sterling series pantry unit comes in 7 luxurious colours
- Available width 450mm, 600mm

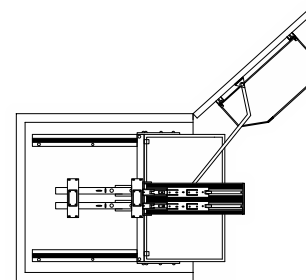

ALUMINIUM WHITE PANTRY WITH SS BASE)

Product	Code	Product Dimension(mm)	MRP
8-Baskets/450	SC GMPN (White) 16 450 MM	385x485XH1200-1450	33000
8-Baskets/600	SC GMPN (White) 21 600 MM	535x485XH1200-1450	36500
12-Baskets/450	SC GPN (White) 16 450 MM	385x485XH1940-2150	39800
12-Baskets/600	SC GPN (White) 21 600 MM	535x485XH1940-2150	43000

Special Features

- The side rail is in white finish aluminium
- The base of the basket is stainless steel.
- Frame & baskets have height adjustment
- Single pullout unit with option of 8 or 12 baskets
- Ergonomically designed integrated mechanism automatically slides out the baskets on opening of the cabinet, making way for optimum reach
- Smooth opening, soft closing, load capacity-100kgs
- Left hand & right hand compatible
- Opening till 110 degree
- The Sterling series pantry unit comes in 7 luxurious colours
- Available width 450mm, 600mm

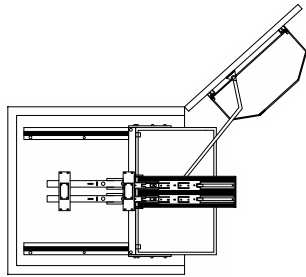

ALUMINIUM WHITE GLASS PANTRY WITH SS BASE

Product	Code	Product Dimension(mm)	MRP
8 - Baskets/450	SC CMPN (White) 16 450 MM	385x485XH1200-1450	33000
8 - Baskets/600	SC CMPN (White) 21 600 MM	535x485XH1200-1450	36500
12 - Baskets/450	SC CPN (White) 16 450 MM	385x485XH1940-2150	39800
12 - Baskets/600	SC CPN (White) 21 600 MM	535x485XH1940-2150	43000

Special Features

- The side rail is in white finish of aluminium with glass
- The base of the basket is stainless steel.
- Frame & baskets have height adjustment
- Single pullout unit with option of 8 or 12 baskets
- Ergonomically designed integrated mechanism automatically slides out the baskets on opening of the cabinet, making way for optimum reach
- Smooth opening, soft closing, load capacity-100kgs
- Left hand & right hand compatible
- Opening till 110 degree
- The Sterling series pantry unit comes in 7 luxurious colours
- Available width 450mm, 600mm

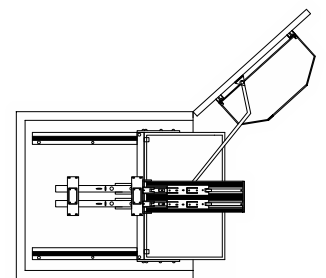

ALUMINIUM GREY PANTRY WITH SS BASE)

Product	Code	Product Dimension(mm)	MRP
8-Baskets/450	SC GMPN (Grey) 16 450 MM	385x485XH1200-1450	33000
8-Baskets/600	SC GMPN (Grey) 21 600 MM	535x485XH1200-1450	36500
12-Baskets/450	SC GPN (Grey) 16 450 MM	385x485XH1940-2150	39800
12-Baskets/600	SC GPN (Grey) 21 600 MM	535x485XH1940-2150	43000

Special Features

- The side rail is in grey finish aluminium
- The base of the basket is stainless steel.
- Frame & baskets have height adjustment
- Single pullout unit with option of 8 or 12 baskets
- Ergonomically designed integrated mechanism automatically slides out the baskets on opening of the cabinet, making way for optimum reach
- Smooth opening, soft closing, load capacity-100kgs
- Left Hand & right Hand compatible
- Opening till 110 degree
- The Sterling series pantry unit comes in 7 luxurious colours
- Available width 450mm, 600mm

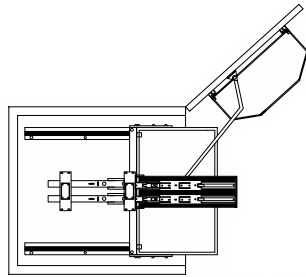
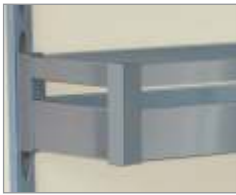

(SS BASE)

ALUMINIUM GREY GLASS PANTRY WITH SS BASE

Product	Code	Product Dimension(mm)	MRP
8-Baskets/450	SC CMPN (Grey) 16 450 MM	385x485XH1200-1450	33000
8-Baskets/600	SC CMPN (Grey) 21 600 MM	535x485XH1200-1450	36500
12-Baskets/450	SC CPN (Grey) 16 450 MM	385x485XH1940-2150	39800
12-Baskets/600	SC CPN (Grey) 21 600 MM	535x485XH1940-2150	43000

Special Features

- The side rail is in grey finish of aluminium with glass
- The base of the basket is stainless steel.
- Frame & baskets have height adjustment
- Single pullout unit with option of 8 or 12 baskets
- Ergonomically designed integrated mechanism automatically slides out the baskets on opening of the cabinet, making way for optimum reach
- Smooth opening, soft closing, load capacity-100kgs
- Left Hand & right Hand compatible
- Opening till 110 degree
- The Sterling series pantry unit comes in 7 luxurious colours
- Available width 450mm, 600mm

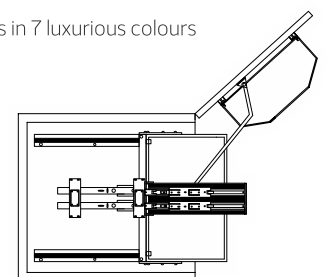

ALUMINIUM BLACK PANTRY WITH SS BASE

Product	Code	Product Dimension(mm)	MRP
8-Baskets/450	SC ZMPN 16 450 MM	385x485XH1200-1450	33000
8-Baskets/600	SC ZMPN 21 600 MM	535x485XH1200-1450	36500
12-Baskets/450	SC ZPN 16 450 MM	385x485XH1940-2150	39800
12-Baskets/600	SC ZPN 21 600 MM	535x485XH1940-2150	43000

Special Features

- The side rail is in black aluminium
- The base of the basket is stainless steel.
- Frame & baskets have height adjustment
- Single pullout unit with option of 8 or 12 baskets
- Ergonomically designed integrated mechanism automatically slides out the baskets on opening of the cabinet, making way for optimum reach
- Smooth opening, soft closing, load capacity-100kgs
- Left hand & right hand compatible
- Opening till 110 degree
- The Sterling series pantry unit comes in 7 luxurious colours
- Available width 450mm,600mm

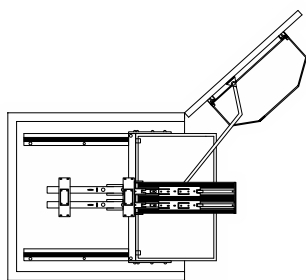

ALUMINIUM BLACK GLASS PANTRY WITH SS BASE

Product	Code	Product Dimension(mm)	MRP
8-Baskets/450	SC CMPN (Z) 16 450 MM	385x485XH1200-1450	33000
8-Baskets/600	SC CMPN (Z) 21 600 MM	535x485XH1200-1450	36500
12-Baskets/450	SC CPN (Z) 16 450 MM	385x485XH1940-2150	39800
12-Baskets/600	SC CPN (Z) 21 600 MM	535x485XH1940-2150	43000

Special Features

- The side rail is in black aluminium with glass
- The base of the basket is stainless steel.
- Frame & baskets have height adjustment
- Single pullout unit with option of 8 or 12 baskets
- Ergonomically designed integrated mechanism automatically slides out the baskets on opening of the cabinet, making way for optimum reach
- Smooth opening, soft closing, load capacity-100kgs
- Left hand & right hand compatible
- Opening till 110 degree
- The Sterling series pantry unit comes in 7 luxurious colours
- Available width 450mm,600mm

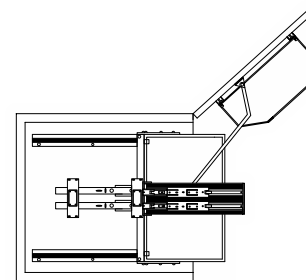

CNC GREY PANTRY SINGLE DOOR

Product	Code	Product Dimension(mm)	MRP
8-Baskets/450	SC CNCN 16 450 MM	385x485XH1200-1450	24500
8-Baskets/600	SC CNCN 21 600 MM	535x485XH1200-1450	28000
12-Baskets/450	SC CNCN 16 450 MM	385x485XH1940-2150	27500
12-Baskets/600	SC CNCN 21 600 MM	535x485XH1940-2150	31000

Special Features

- The side rail is CNC GREY
- The base of the basket is GI steel
- Frame & baskets have height adjustment
- Single pullout unit with option of 8 or 12 baskets
- Ergonomically designed integrated mechanism automatically slides out the baskets on opening of the cabinet, making way for optimum reach
- Smooth opening, soft closing, load capacity-100kgs
- Left hand & right hand compatible
- Opening till 110 degree
- The Sterling series pantry unit comes in 7 luxurious colours
- Available width 450mm,600mm

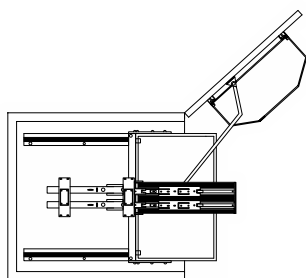

CNC GREY PANTRY DOUBLE DOOR

Product	Code	Product Dimension(mm)	MRP
8-Baskets/450	SC CMPN (Z) 16 450 MM	385x485XH1200-1450	24500
8-Baskets/600	SC CMPN (Z) 21 600 MM	535x485XH1200-1450	28000
12-Baskets/450	SC CPN (Z) 16 450 MM	385x485XH1940-2150	27500
12-Baskets/600	SC CPN (Z) 21 600 MM	535x485XH1940-2150	31000

Special Features

- The side rail is CNC GREY
- The base of the basket is GI steel
- Frame & baskets have height adjustment
- Single pullout unit with option of 8 or 12 baskets
- Ergonomically designed integrated mechanism automatically slides out the baskets on opening of the cabinet, making way for optimum reach
- Smooth opening, soft closing, load capacity-100kgs
- Left hand & right hand compatible
- Opening till 110 degree
- The Sterling series pantry unit comes in 7 luxurious colours
- Available width 450mm,600mm

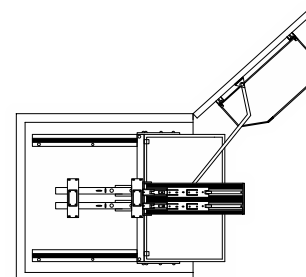

UNIVERSAL CORNER



Code	Size(in mm)	MRP
CULGC (Universal)	900 - 1000	28333

Code	Size(in mm)	MRP
CNC GREY (Universal)	900 - 1000	27500

INSTALLATION PROCESS

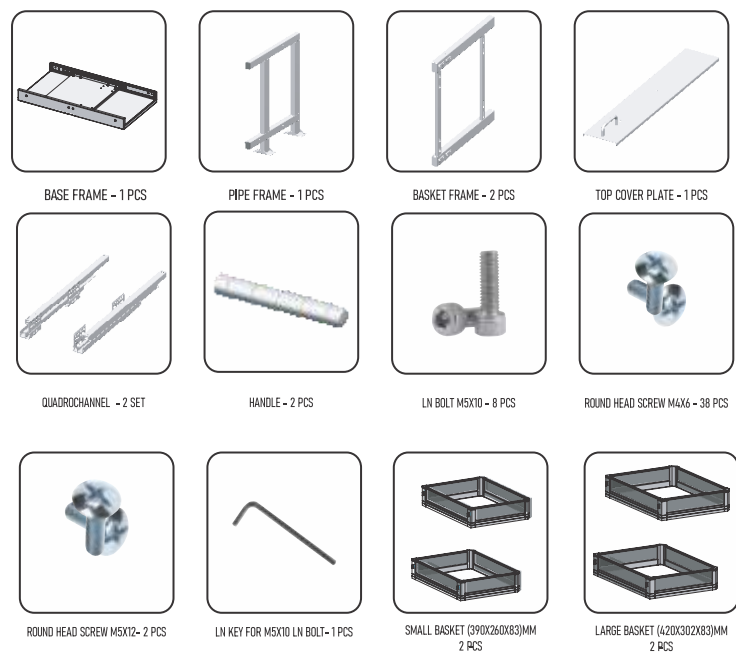
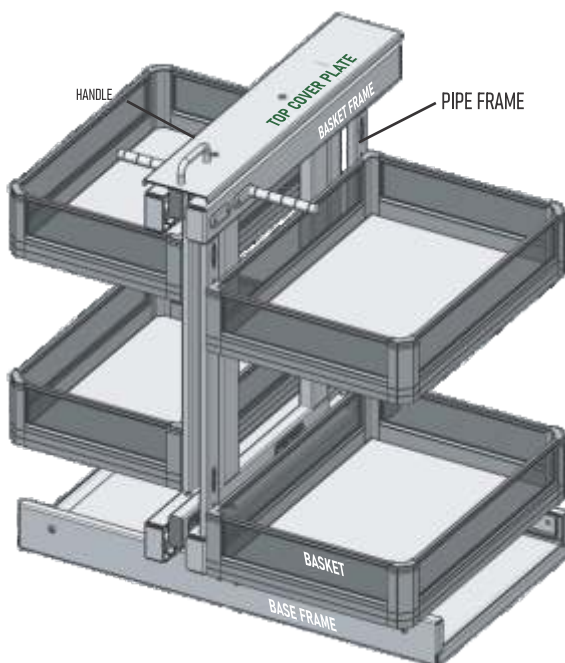
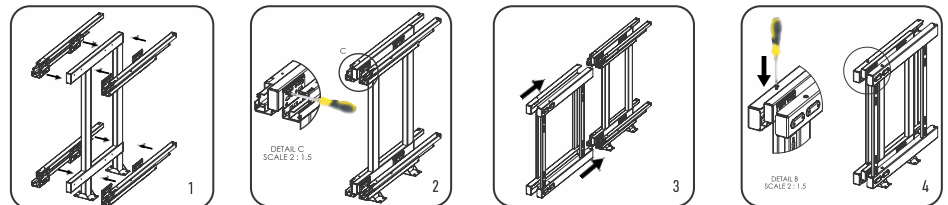

ROUND CAROUSEL 270° 3/4



Code	Size(mm)	MRP
EO-436C-RC-700	700	15500
EO-436D-RC-800	800	17500

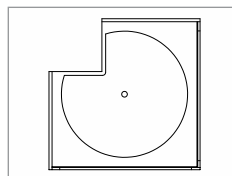

Product features

- Side grill chrome plated SS
- The basket base is wooden
- Height adjustable axle
- Provide optimal use of space

S-CAROUSEL



Code	Side	MRP
SC GSCR LH	Left	18000
SC GSCR RH	Right	18000

Product features

- Ideal for blind corner, allows full accessibility to the entire unit
- Tray height is adjustable. Each tray is independent & can be pulled out individually
- High railing ensures better hold of goods in each shelf
- Ultra smooth, silent, effortless closing & opening. Load capacity 20kgs
- Simple assembly, easy set up, excellent durability
- Available in left opening & right opening

S-CAROUSEL WITH MATT



Code	Side	MRP
SC GSCRM LH	Left	18000
SC GSCRW RH	Right	18000

Product features

- Ideal for blind corner, allows full accessibility to the entire unit
- Tray height is adjustable. Each tray is independent & can be pulled out individually
- Anti skid matt & high railing ensures better hold of goods
- Ultra smooth, silent & effortless closing. Load capacity 20kgs
- Simple assembly, easy set up, excellent durability
- Available in left opening & right opening

S-CAROUSEL WITH WIRE



Code	Side	MRP
EO-434A-SCW-L	Left	18000
EO-432B-SCW-R	Right	18000

Product features

- Ideal for blind corner, allows full accessibility to the entire unit
- Tray height is adjustable. Each tray is independent & can be pulled out individually
- High railing ensures better hold goods in each shelf
- Ultra smooth, silent & effortless closing. Load capacity 20kgs
- Simple assembly, easy set up, excellent durability
- Available in left opening & right opening



GLASS & GREY BASE

Code	Size(mm)	Shelf	MRP
CBPO 150/2	150	2	6850
CBPO 200/2	200	2	7334
CBPO 250/2	250	2	8000
CBPO 300/2	300	3	8668

Product Features

- The side railing is of tempered glass
- The basket base is of stainless steel sheet.
- Pull out with soft closing. Load capacity of 45kgs
- Provides optimal use of space & excellent access from both sides
- The adjustable shelves & railings prevent bottles & spice jars from falling over or out
- Designed for high quality anti rust functions
- Available sizes 150mm, 200mm, 250mm, 300mm & 350mm

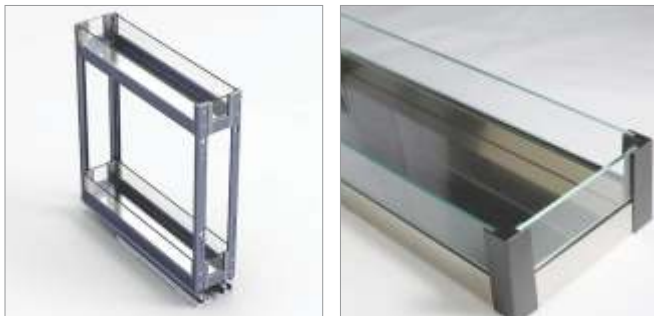

SATIN & GREY BASE

Code	Size(mm)	Shelf	MRP
GBPO (C) 150	150	2	6850
GBPO (C) 200	200	2	7334
GBPO (C) 250	250	2	8000
GBPO (C) 300	300	3	8668

Product Features

- The side railing is in satin finish stainless steel
- The basket base is of stainless steel sheet.
- Pull out with soft closing. Load capacity of 45kgs
- Provides optimal use of space & excellent access from both sides
- The adjustable shelves & railings prevent bottles & spice jars from falling over or out
- Designed for high quality anti rust functions
- Load capacity of 30kgs
- Available sizes 150mm, 200mm, 250mm, 300mm & 350mm



PVD ROSE GOLD BOTTLE PULLOUT (SS BASE WITH QUADRO)



Code	Size(mm)	Shelf	MRP
RBPO 150/2	150	2	9795
RBPO 200/2	200	2	10678
RBPO 250/2	250	2	11440
RBPO 300/2	300	2	12395

GLASS SERIES (SS BASE WITH QUADRO)

CBPO (R) 150/2	150	2	9795
CBPO (R) 200/2	200	2	10678
CBPO (R) 250/2	250	2	11440
CBPO (R) 300/2	300	2	12395

SS PVD GOLD BOTTLE PULLOUT (SS BASE WITH QUADRO)



Code	Size(mm)	Shelf	MRP
YBPO 150	150	2	9795
YBPO 200	200	2	10678
YBPO 250	250	2	11440
YBPO 300	300	2	12395

GLASS SERIES (SS BASE WITH QUADRO)

CBPO (Y) 150	150	2	9795
CBPO (Y) 200	200	2	10678
CBPO (Y) 250	250	2	11440
CBPO (Y) 300	300	2	12395

SS PVD TITANIUM BLACK (SS BASE WITH QUADRO)



Code	Size(mm)	Shelf	MRP
ZBPO 150	150	2	9795
ZBPO 200	200	2	10678
ZBPO 250	250	2	11440
ZBPO 300	300	2	12395

GLASS SERIES (SS BASE WITH QUADRO)

CBPO (Z) 150	150	2	9795
CBPO (Z) 200	200	2	10678
CBPO (Z) 250	250	2	11440
CBPO (Z) 300	300	2	12395

Special Features

- The basket base is of stainless steel sheet.
- Pull out with soft closing. Load capacity of 45kgs
- Provides optimal use of space & excellent access from both sides
- The adjustable shelves & railings prevent bottles & spice jars from falling over or out

- The specially developed finish is anti corrosive & avoids the metal parts from rusting under harsh conditions
- The Sterling series BPO & MPO comes in 7 luxurious colours
- Available in 150mm, 200mm, 250mm, 300mm & 350 mm



ALUMINIUM WOODEN (SS BASE WITH QUADRO)



Code	Size(mm)	Shelf	MRP
TBPO 150	150	2	9042
TBPO 200	200	2	9857
TBPO 250	250	2	10560
TBPO 300	300	2	11442

GLASS SERIES (SS BASE WITH QUADRO)

CBPO (T) 150	150	2	9042
CBPO (T) 200	200	2	9857
CBPO (T) 250	250	2	10560
CBPO (T) 300	300	2	11442

ALUMINIUM GREY (SS BASE WITH QUADRO)



Code	Size(mm)	Shelf	MRP
GBPO (GREY) 150	150	2	9042
GBPO (GREY) 200	200	2	9857
GBPO (GREY) 250	250	2	10560
GBPO (GREY) 300	300	2	11442

GLASS SERIES (SS BASE WITH QUADRO)

CBPO (GREY) 150	150	2	9042
CBPO (GREY) 200	200	2	9857
CBPO (GREY) 250	250	2	10560
CBPO (GREY) 300	300	2	11442

ALUMINIUM WHITE (SS BASE WITH QUADRO)



Code	Size(mm)	Shelf	MRP
GBPO (WHITE) 150	150	2	9042
GBPO (WHITE) 200	200	2	9857
GBPO (WHITE) 250	250	2	10560
GBPO (WHITE) 300	300	2	11442

GLASS SERIES (SS BASE WITH QUADRO)

CBPO (WHITE) 150	150	2	9042
CBPO (WHITE) 200	200	2	9857
CBPO (WHITE) 250	250	2	10560
CBPO (WHITE) 300	300	2	11442

Special Features

- The basket base is of stainless steel sheet.
- Pull Out with Soft Closing. Load capacity of 45Kgs
- Provides optimal use of space & excellent access from both sides
- The Adjustable shelves & railings prevent bottles & Spice Jars from falling over or out

- The specially developed finish is anti corrosive & avoids the metal parts from rusting under harsh conditions
- The Sterling series BPO & MPO comes in 7 luxurious colours
- Available in 150mm, 200mm, 250mm, 300mm & 350 mm



ALUMINIUM BLACK (SS BASE WITH QUADRO)



Code	Size(mm)	Shelf	MRP
ZABPO 150	150	2	9042
ZABPO 200	200	2	9857
ZABPO 250	250	2	10560
ZABPO 300	300	2	11442

GLASS SERIES (SS BASE WITH QUADRO)

CBPO (ZA) 150	150	2	9042
CBPO (ZA) 200	200	2	9857
CBPO (ZA) 250	250	2	10560
CBPO (ZA) 300	300	2	11442

ALUMINIUM SATIN (SS BASE WITH QUADRO)



Code	Size(mm)	Shelf	MRP
GABPO 150	150	2	9042
GABPO 200	200	2	9857
GABPO 250	250	2	10560
GABPO 300	300	2	11442

GLASS SERIES (SS BASE WITH QUADRO)

CBPO (GA) 150	150	2	9042
CBPO (GA) 200	200	2	9857
CBPO (GA) 250	250	2	10560
CBPO (GA) 300	300	2	11442

ALUMINIUM MIRROR (SS BASE WITH QUADRO)



Code	Size(mm)	Shelf	MRP
GBPO (C) 150	150	2	9042
GBPO (C) 200	200	2	9857
GBPO (C) 250	250	2	10560
GBPO (C) 300	300	2	11442

GLASS SERIES (SS BASE WITH QUADRO)

CBPO (C) 150	150	2	9042
CBPO (C) 200	200	2	9857
CBPO (C) 250	250	2	10560
CBPO (C) 300	300	2	11442

Special Features

- The basket base is of stainless steel sheet.
- Pull Out with Soft Closing. Load capacity of 45Kgs
- Provides optimal use of space & excellent access from both sides
- The Adjustable shelves & railings prevent bottles & Spice Jars from falling over or out

- The specially developed finish is anti corrosive & avoids the metal parts from rusting under harsh conditions
- The Sterling series BPO & MPO comes in 7 luxurious colours
- Available in 150mm, 200mm, 250mm, 300mm & 350 mm





SPO SS PVD WITH SS BASE

Code	Size(mm)	Shelf	MRP
GSPO	200	2	11088
GSPO	250	2	11880
GSPO	300	2	12872



SPO CNC GREY

Code	Size(mm)	Shelf	MRP
CNC SPO	200	2	8214
CNC SPO	250	2	8800
CNC SPO	300	2	9535



SPO SATIN ALUMINIUM WITH SS BASE

Code	Size(mm)	Shelf	MRP
GSPO	200	2	10267
GSPO	250	2	11000
GSPO	300	2	11918

Product Features

- The side railing is of tempered glass & satin finish
- Pull out with soft closing. Load capacity of 45kgs
- Provides optimal use of space & excellent access from both sides
- The adjustable shelves & railings prevent bottles & spice jars from falling over or out
- Designed for high quality anti rust functions
- Available sizes 150mm, 200mm, 250mm, 300mm & 350mm
- Available in 6 colours in aluminium & 3 colours in SS PVD



PLAIN BASKET



Code	4" MRP	6" MRP	8" MRP
EPB 15 20	1476	1769	2112
EPB 17 20	1752	2110	2539
EPB 19 20	1939	2350	2740
EPB 21 20	2040	2430	2880
EPB 24 20	2260	2730	3180
EPB 28 20	2540	3090	3550
EPB 32 20	2720	3300	3970

CUP & SAUCER BASKET (INBUILT PARTITION)



Code	Available Height Size (Inches)	MRP
ECB 15 20	4	1676
ECB 17 20	4	1992
ECB 19 20	4	2220
ECB 21 20	4	2360

PLATE BASKET (INBUILT PARTITION)



Code	Available Height Size (Inches)	MRP
EPT 15 20	6	2009
EPT 17 20	6	2386
EPT 19 20	6	2670
EPT 21 20	6	2790

THALLI BASKET (INBUILT PARTITION)



Code	Available Height Size (Inches)	MRP
ETH 15 20	8	2393
ETH 17 20	8	2860
ETH 19 20	8	3100
ETH 21 20	8	3281

PERFORATED CUTLERY BASKET (INBUILT PARTITION)



Code	Available Height Size (Inches)	MRP
UCT 15 20	4	2800
UCT 17 20	4	3300
UCT 19 20	4	3800
UCT 21 20	4	4300

CUTLERY PARTITION



Code	Size	MRP
CTSPA	15"	1500
CTSPA	17"	1800
CTSPA	19"	2100
CTSPA	21"	2400



RICE PULLOUT



Code	Cabinet Size (mm)	MRP
RPO 9	300	12412
RPO 9 Q	300	13774

SIDE MOUNTED PULLOUT



Code	Cabinet Size (mm)	Code
SPO 6/2	200	4817
SPO 8/2	250	5402
SPO 12/2	350	6050

GRAIN TROLLY (WITH QUADRO)



Code	Cabinet Size (mm)	Code
GPO 15 Q	450	5652
GPO 17 Q	500	6341
GPO 19 Q	550	7054
GPO 21 Q	600	7727

BOTTLE PULLOUT 3 SHELVES



Code	Cabinet Size (mm)	MRP
EBPO 4/3 N	150	3114
EBPO 6/3 N	200	3832
EBPO 8/3 N	250	4453
EBPO 9/3 N	300	6276
EBPO 12/3 N	400	7801

BOTTLE PULLOUT 2 SHELVES



Code	Cabinet Size (mm)	MRP
EBPO 4/2 N	150	2311
EBPO 6/2 N	200	2735
EBPO 8/2 N	250	3132
EBPO 9/2 N	300	4089
EBPO 12/2 N	400	4550

CAROUSEL



Code	MRP
CR 20	5122
CR 24	6217
CR 28	6970

CUP & SAUCER



Code	MRP
CBPA	1008

PLATE PARTITION



Code	MRP
PTPA	1008

THALI PARTITION



Code	MRP
THPA	1008



WIRE BASKET Q SERIES GREY

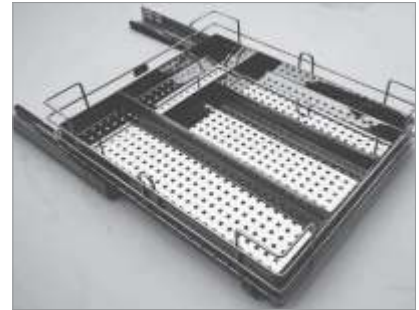

Code	4" MRP	6" MRP	8" MRP
EQPB 15 20	2574	2891	3263
EQPB 17 20	2873	3260	3726
EQPB 19 20	3076	3520	3943
EQPB 21 20	3185	3608	4095
EQPB 24 20	3423	3933	4420
EQPB 28 20	3727	4323	4820
EQPB 32 20	3922	4550	5275

Code	Available Height Size (Inches)	MRP
EQVEG 15 20	6	4160
EQVEG 17 20	6	4550
EQVEG 19 20	6	4940
EQVEG 21 20	6	5330

SIDE MOUNTING PULLOUT

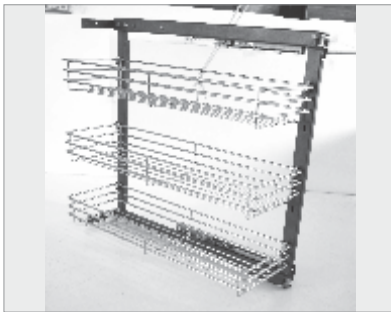

Code	Shelf Size	MRP
EQSPO	200/2	4817
EQSPO	250/2	5402
EQSPO	300/2	6050

GRAIN TROLLEY (WITH QUADRO)

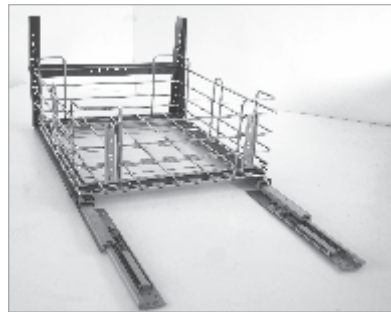

Code	Cabinet Size (mm)	MRP
EQGPO 15	450	5652
EQGPO 17	500	6341
EQGPO 19	550	7054
EQGPO 21	600	7727

CUTLERY PARTITION



Code	Cabinet Size (mm)	MRP
CTS PA 15"	450	1500
CTS PA 17"	500	1800
CTS PA 19"	550	2100
CTS PA 21"	600	2400

WIRE BASKET Q SERIES



Thali Partition

Code	MRP
UTHPA	780

Plate Partition

Code	MRP
UPTPA	780

Cup & Saucer Partition

Code	MRP
UCBPA	780



PARTITION



Code	MRP
PA	360

GLASS PARTITION



Code	MRP
GLSPA	360

BOTLE PARTITION



Code	MRP
BOTPA	360

CUP & SAUCER GREY



Code	MRP
CBPA	1000

PLATE PARTITION GREY



Code	MRP
PTPA	1000

THALI PARTITION GREY



Code	MRP
THPA	1050

CUTLERY PARTITION GREY



Code	Size (Inch)	MRP
CTSPA	15"	1200
CTSPA	17"	1400
CTSPA	19"	1600
CTSPA	21"	1800

CORNER GREY



Code	Size (Inch)	MRP
CORNER	12"	1300
CORNER	14"	1500
CORNER	16"	1700

SHELF GREY



Code	Size (Inch)	MRP
SHELF	12"	1300
SHELF	14"	1500
SHELF	16"	1700





PULL DOWN UNIT - GLASS

Code	Size(mm)	MRP
EO-479A-PD-600-GL	600mm	22500
EO-479B-PD-900-GL	900mm	24500

WITH BEADING

Code	Size(mm)	MRP
EO-479A-PD-600-GL	600mm	27000
EO-479B-PD-900-GL	900mm	29000

Special Features

- Elegant look with tempered glass railing
- Pull down system for higher wall cabinets
- The entire system can be pulled down or pushed back & has soft down-soft up features
- Dismountable frame & height adjustable shelves
- Pull force adjustable
- Available sizes 600mm & 900mm



WHITE GLASS



Code	Size(mm)	MRP
EO-484A-RS-600-GLW	600	34500



BLACK GLASS



Code	Size(mm)	MRP
EO-484B-RS-600-GLB	600	34500

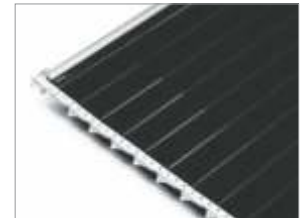

FROSTED GLASS



Code	Size(mm)	MRP
EO-484C-RS-600-GLF	600	34500



Special Features

- Smart alternative to traditional hinged or sliding doors
- Save upto 30% more space as compared regular swing doors
- Made of high grade tempered glass, easy to handle & install
- Can withstand extreme heat, steam & wet conditions

- Fine design for noise free movement & longer service life
- Available width 600mm

ALUMINIUM ROLLING SHUTTER



Code	Size(mm)	Finish	MRP
EO-480A-RS-450-AL	450	Anodized	22500
EO-480B-RS-600-AL	600	Anodized	25500
EO-480C-RS-900-AL	900	Anodized	34000

Special Features

- Smart alternative to traditional hinged or sliding doors
- Save upto 30% more space as compared regular swing doors
- Durable anodized finish on aluminium body
- Can withstand extreme heat, steam & wet conditions
- Fine design for noise free movement & longer service life
- Available sizes 450mm, 600mm & 900mm

PVC ROLLING SHUTTER



Code	Size(mm)	Finish	MRP
EO-482A-RS-450-PVC	450	Anodized	17000
EO-482B-RS-600-PVC	600	Anodized	17500
EO-482C-RS-450-PVC-BK	450	Black	17000
EO-482D-RS-600-PVC-BK	600	Black	17500
EO-482E-RS-450-PVC-W	450	White	17000
EO-482F-RS-600-PVC-W	600	White	17500

Special Features

- Smart alternative to traditional hinged or sliding doors
- Save upto 30% more space as compared regular swing doors
- Durable silver finish on ABS plastic
- Can withstand extreme heat, steam & wet conditions
- Fine design for noise free movement & longer service life
- Available sizes 450mm & 600mm



CUTLERY PVC - GREY



Code	Size(mm)	MRP
EK-500A-CT-450-PVC	450	980
EK-500B-CT-500-PVC	500	1030
EK-500B-CT-600-PVC	600	1080
EK-500C-CT-700-PVC	700	1400
EK-500D-CT-800-PVC	800	1500
EK-500E-CT-900-PVC	900	1650

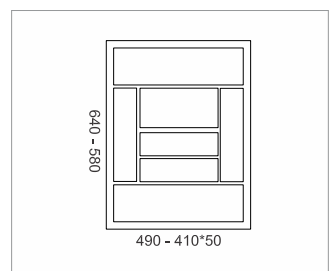
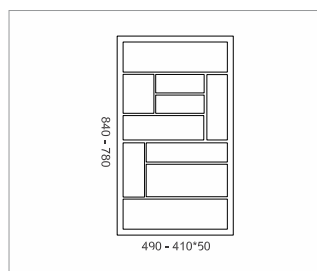
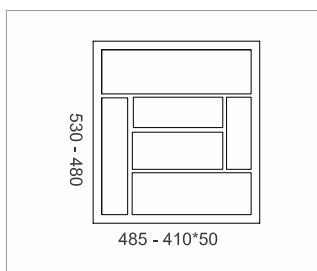
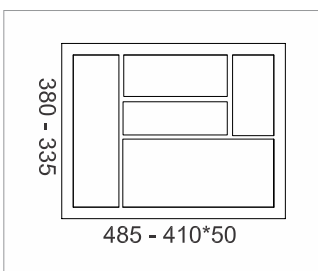

Product Features

- Seamless glossy finish in grey colour
- Made from ABS. It is non toxic & food grade
- Good product to effectively organise your kitchen cutlery
- Elegant design, easy to clean
- Available in 4 different sizes

CUTLERY WOODEN



Code	Size(mm)	MRP
EK-504A-CT-600-WD	400-600	12500
EK-504B-CT-900-WD	600-900	14000

Product Features

- Made from high quality steam beach wood.
- The versatile & appealing drawer insert comes in adjustment in widths
- Good product to effectively organise your kitchen cutlery
- Elegant design, adjustable size, easy to clean
- Available sizes 600mm & 900mm

WOODEN SPICE RACK



Code	Size(mm)	MRP
EK-505A-SR-600-WD	600	6500
EK-505B-SR-900-WD	900	9000

Product Features

- Made from high quality steam beach wood.
- Smart organizer with cutouts for effective storage of spice & other jars
- Available sizes 600mm & 900mm

PLATE MANAGER WITH STICK



Code	Size(mm)	MRP
EK-506A-PMS-600-WD	600	6500
EK-506B-PMS-900-WD	900	9000

Product Features

- Made from high quality steam beach wood.
- Smart organizer with combination of dovetail & accessories
- Posts mount into pre-drilled holes
- Available sizes 600mm & 900mm

NATURAL WOOD

Product	Code	Size(mm)	MRP
Wicker Basket 4-Inches	NATURAL WOOD	100 x450	5200
	NATURAL WOOD	100x600	5600
Wicker Basket 6-Inches	NATURAL WOOD	150x450	5200
	NATURAL WOOD	150x600	5600
Wicker Basket 8-Inches	NATURAL WOOD	200x450	5200
	NATURAL WOOD	200x600	5600

Product Features

- Made out of willows of natural wood brown colour
- Keep vegetables to stay fresh for days
- Light weight but sturdy & durable.
- Easy to maintain & comes as a ready to install unit
- Available in 2 finishes & 6 sizes

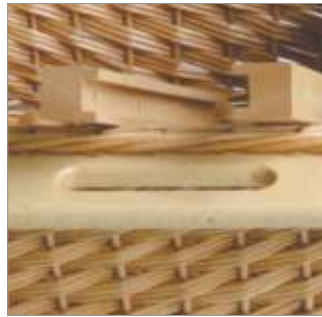

CNC GREY WITH QUADRO SLIDE

Product	Code	Size(mm)	MRP
Wicker Basket 4-Inches	CNC GREY	100x450	5500
	CNC GREY	100x600	5900
Wicker Basket 6-Inches	CNC GREY	150x450	5500
	CNC GREY	150x600	5900
Wicker Basket 8-Inches	CNC GREY	200x450	5500
	CNC GREY	200x600	5900

Product Features

- Made out by Galvanised steel of Grey colour polished in dark Imported Grey Powder.
- Keep vegetables to stay fresh for days
- Light weight but sturdy & durable.
- Easy to maintain & comes as a ready to install unit
- Available in 2 finishes & 6 sizes





DISH RACK WITH DRIP TRAY

Code	Size(mm)	MRP
DISH RACK 600	600	1800
DISH RACK 700	700	2100
DISH RACK 800	800	2400
DISH RACK 900	900	2700
DISH RACK 1000	1000	3000

Product Features

- Made of stainless steel.
- Optimal for both modular & non modular type of kitchen
- Special spring loaded anchors help secure the shelf
- Consist of two layers, one dish drainer & one cutlery drainer
- Unique water collecting tray to collect residual water
- Available in 5 sizes



SLIDING DOUBLE DUSTBIN



Code	MRP
EK-530-SDD	8800

Product Features

- MS powder coated - grey colour
- Compact design with a capacity of 28ltrs (14Lx2)
- Manual operations. Removable buckets add to the convenience
- Quick installation, mounts on the floor of the cabinet under every kind of the sink
- Full extension slides provide for easy access to the buckets

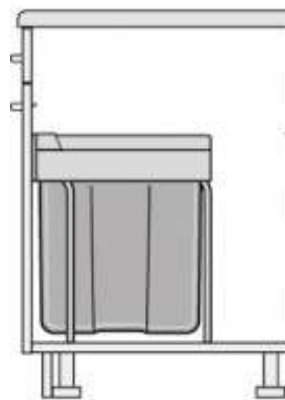

AUTO LID DUSTBIN



Code	Size	MRP
ADB 8	8Ltrs	3250
ADB 14	14ltrs	3850

Product Features

- This bin has an automatic opening system for lids.
- Strong & durable finish
- It has a removable trash bucket with swing lid for convenience.
- Nontoxic premium plastic used for long life.
- Available in elegant stainless steel finish

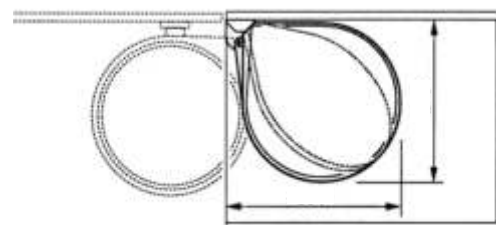

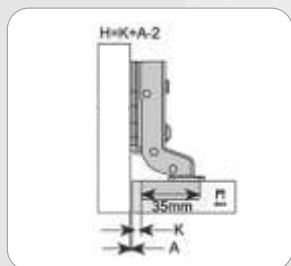
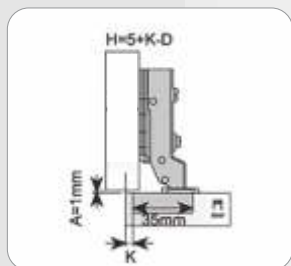
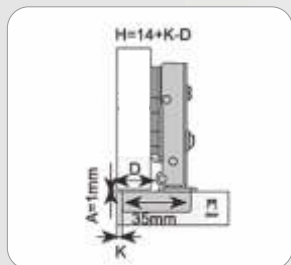

FIX ON HINGES SS/MS

Code	Cranking	Size	MRP
FIX ON HINGES 0 F	0 Crank	Full Overlay	190
FIX ON HINGES 8 H	8 Crank	Half Overlay	190
FIX ON HINGES 0 F S.S	0 Crank	Full Overlay	230
FIX ON HINGES 8 H S.S	8 Crank	Half Overlay	230

Product Features

- Concealed hinge with slide on assembly
- Opening angle 110°
- Height of the hinge cup : 11.3mm
- Diameter of hinge cup : 35mm
- Distance between door edge to the cup : 3-7mm
- Packing unit includes screws
- Height adjustment at mounting plate
- Recommended door thickness - 14-23mm
- 4 holes mounting plate

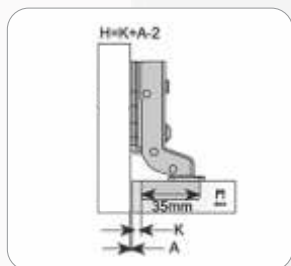
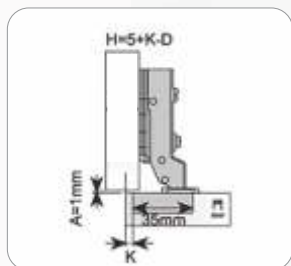
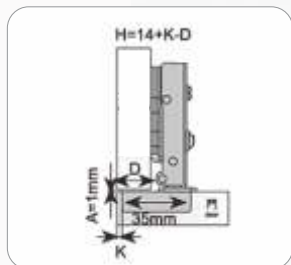

CLIP ON SOFT CLOSE 2D HINGE MS/SS

Code	Cranking	Size	MRP
SC HINGES 0 F 2D MS	0 Crank	Full Overlay	220
SC HINGES 8 H 2D MS	8 Crank	Half Overlay	220
SC HINGES 15 H 2D MS	15 Crank	Insert	220
SC HINGES 0 F 2D SS	0 Crank	Full Overlay	250
SC HINGES 8 H 2D SS	8 Crank	Half Overlay	250
SC HINGES 15 2D SS	15 Crank	Insert	250

Product Features

- Concealed hinge with slide on assembly
- Opening angle 110°
- Height of the hinge cup : 11.3mm
- Diameter of hinge cup : 35mm
- Distance between door edge to the cup : 3-7mm
- Packing unit includes screws
- Height adjustment at mounting plate
- Recommended door thickness - 14-23mm
- 4 holes mounting plate

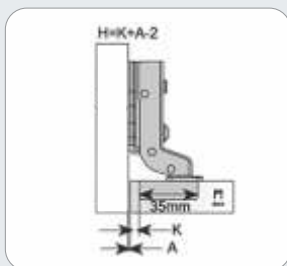
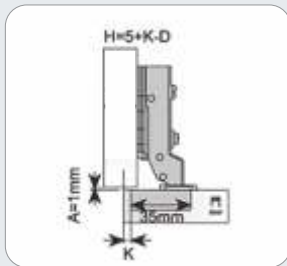
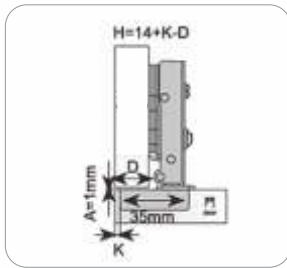

CLIP ON SOFT CLOSE 3D HINGE MS/SS

Code	Cranking	Size	MRP
SC HINGES 0 F 3D MS	0 Crank	Full Overlay	280
SC HINGES 8 H 3D MS	8 Crank	Half Overlay	280
SC HINGES 15 H 3D MS	15 Crank	Insert	280
SC HINGES 0 F 3D SS	0 Crank	Full Overlay	350
SC HINGES 8 H 3D SS	8 Crank	Half Overlay	350
SC HINGES 15 3D SS	15 Crank	Insert	350

Product Features

- Concealed hinge with slide on assembly
- Opening angle 110°
- Height of the hinge cup : 11.3mm
- Diameter of hinge cup : 35mm
- Distance between door edge to the cup : 3-7mm
- Packing unit includes screws
- Height adjustment at mounting plate
- Recommended door thickness - 14-23mm
- 4 holes mounting plate

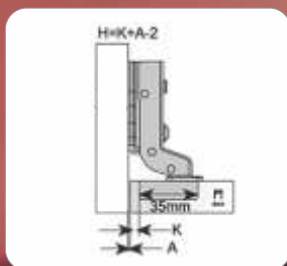
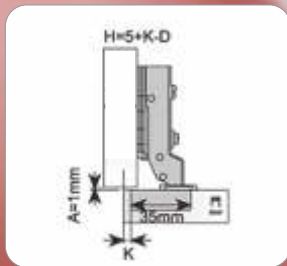
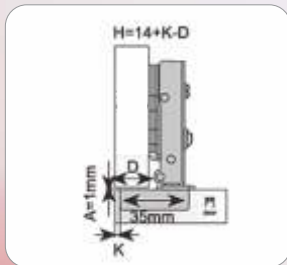

SLIDE ON HINGE

Code	Cranking	Size	MRP
Normal Hinges 0	0 Crank	Full Overlay	100
Normal Hinges 8	8 Crank	Half Overlay	100

Product Features

- Concealed hinge with slide on assembly
- Opening angle 110°
- Height of the hinge cup : 11.3mm
- Diameter of hinge cup : 35mm
- Distance between door edge to the cup : 3-7mm
- Packing unit includes screws
- Height adjustment at mounting plate
- Recommended door thickness - 14-23mm
- 4 holes mounting plate

CLIP ON SOFT CLOSE 3D HINGE MS - BLACK WITH HOOK



Code	Cranking	Size	MRP
SC Hinges 3D Black	0 Crank	Full Overlay	450
SC Hinges 3D Black	8 Crank	Full Overlay	450
SC Hinges 3D Black	15 Crank	Full Overlay	450

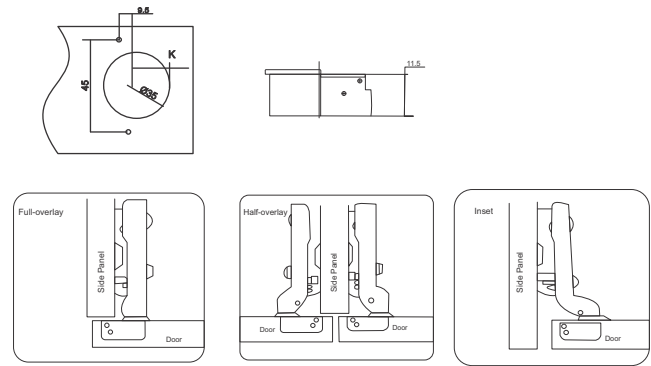

CLIP ON SOFT CLOSE 3D HINGE MS - BLACK



Code	Cranking	Size	MRP
SC Hinges 3D Black	0 Crank	Full Overlay	360
SC Hinges 3D Black	8 Crank	Full Overlay	360
SC Hinges 3D Black	15 Crank	Full Overlay	360

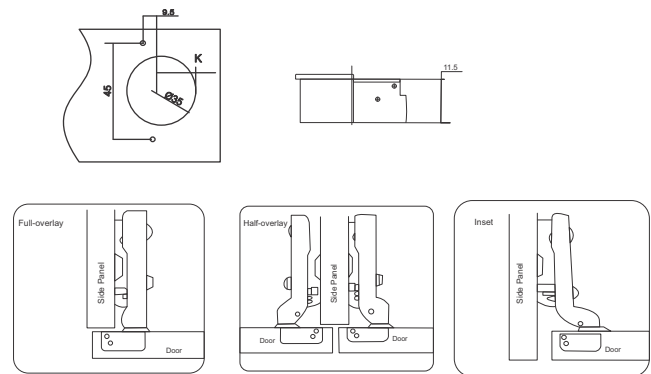

CLIP ON SOFT CLOSE 22 mm HINGE MS - BLACK



Code	MRP
Profile Hinges 22mm	380

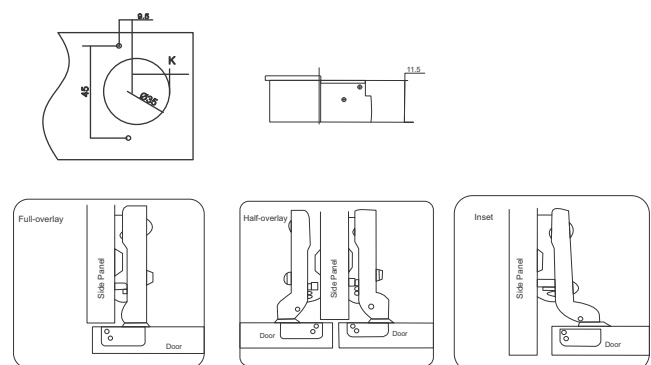

165° CORNER WIDE ANGLE HINGE



Code	Size	MRP
Hinges 165	Full Overlay	440

Product Features

- Concealed hinge with slide on assembly
- Opening angle : 165°
- Height of the hinge cup : 11.3mm
- Diameter of hinge cup : 35mm
- Height adjustment at mounting plate
- Packing unit includes screws
- Recommended door thickness - 14-25mm
- 4 holes mounting plate

165° CORNER SOFT CLOSE WIDE ANGLE HINGE



Code	Size	MRP
SC Hinges 165	Full Overlay	900

Product Features

- Concealed hinge with clip on assembly & silent closing
- Opening angle : 165°
- Height of the hinge cup : 11.3mm
- Diameter of hinge cup : 35mm
- Height adjustment at mounting plate
- Packing unit include screws
- Recommended door thickness - 14-23mm
- 4 holes mounting plate

BLIND CORNER 90° HINGE



Code	Size	MRP
Blind 90°	Full Overlay	280

Product Features

- Concealed hinge with slide on assembly
- Opening angle : 90°
- Height of the hinge cup : 11.3mm
- Diameter of hinge cup : 35mm
- Distance between door edge to the cup : 3-7mm
- Height adjustment at mounting plate
- Packing unit includes screws
- Recommended door thickness - 14-23mm
- 4 holes mounting plate

BLIND CORNER 90° SOFT CLOSE HINGE



Code	Size	MRP
SC Blind 90°	Full Overlay	470

Product Features

- Concealed hinge with clip on assembly & silent closing
- Opening Angle : 90°
- Height of the hinge cup : 11.3mm
- Diameter of hinge cup : 35mm
- Distance between door edge to the cup : 3-7mm
- Height adjustment at mounting plate
- Packing unit includes screws
- Recommended door thickness - 14-23mm
- 4 holes mounting plate

PIE CORNER 135° HINGE



Code	Size	MRP
Pie Corner 135°	Full Overlay	240

Product Features

- Concealed hinge with slide on assembly
- Opening angle : 135°
- Height of the hinge cup : 11.3mm
- Diameter of hinge cup : 35mm
- Distance between door edge to the cup : 3 - 7mm
- Height adjustment at mounting plate
- Packing unit includes screws
- Recommended door thickness - 14-23mm
- 4 holes mounting plate

BALL BEARING SLIDES (ZINC, BLACK)



Code	Size	MRP 35kg	MRP 45kg
Telescopic Channel	10"	333	366
Telescopic Channel	12"	400	440
Telescopic Channel	14"	467	513
Telescopic Channel	16"	533	587
Telescopic Channel	18"	600	660
Telescopic Channel	20"	667	733
Telescopic Channel	22"	733	806
Telescopic Channel	24"	800	880

Product Features

- Zinc plated high quality steel with international advanced spray paint technology
- High precision steel ball assembling for smooth & silent rolling
- With release lever, the drawer can be detached from the runner & re-fitted with ease
- 50000 open-close cycle tested
- Load capacity - 45kgs
- Available in 10 sizes

BALL BEARING SLIDES STAINLESS STEEL



Code	Size(inches)	35kg MRP
SS Telescopic Channel	10"	500
SS Telescopic Channel	12"	600
SS Telescopic Channel	14"	700
SS Telescopic Channel	16"	800
SS Telescopic Channel	18"	900
SS Telescopic Channel	20"	1000
SS Telescopic Channel	22"	1100

Product Features

- Silent system-the integrated push to open function
- Zinc plated high quality steel with international advanced spray paint technology
- High precision steel ball assembling for smooth & silent rolling
- With release lever, the drawer can be detached from the runner & Re-fitted with ease
- 50000 open-close cycle tested
- Load capacity-45kgs
- Available in 6 sizes

BALL BEARING SLIDE SOFT CLOSE (ZINC, BLACK)



Code	Size(inches)	MRP
SC Telescopic Channel	12"	680
SC Telescopic Channel	14"	793
SC Telescopic Channel	16"	906
SC Telescopic Channel	18"	1020
SC Telescopic Channel	20"	1133
SC Telescopic Channel	22"	1247

Product Features

- Full extension runner with integrated soft-closing function
- Zinc plated high quality steel with international advanced spray paint technology
- The robust, silent tracks provide the steel balls with optimum control
- 50000 open-close cycle tested
- Load capacity - 30Kgs & 45kgs

WOODEN QUADRO SLIDE V6



Code	Size(inches)	MRP
Wooden Quadro Slide	12"	1120
Wooden Quadro Slide	14"	1307
Wooden Quadro Slide	16"	1493
Wooden Quadro Slide	18"	1680
Wooden Quadro Slide	20"	1868
Wooden Quadro Slide	22"	2053

WOODEN QUADRO SLIDE SYNCHRONISED



Code	Size(inches)	MRP
Wooden Quadro Slide	18"	2100
Wooden Quadro Slide	20"	2350
Wooden Quadro Slide	22"	2570

CABINET CONNECTING SCREW

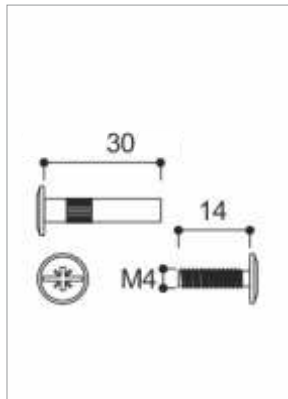

Code	Size(mm)	MRP
EA-908-CS30	30	7

Product Features

- Pan head
- Comes with 1 threaded screw & 1 sleeve
- Used to join boards of various thickness.
- Also acts as a dowel.
- Screws and sleeves are nickel plated for good aesthetics.

WOODEN DOWEL



Code	Size(mm)	MRP
EA-909-WD	8 x 40	1.5
EA-909A-PVC	8 x 40	1.5

Product Features

- Dowel pins are currently available in 8mm diameter
- Pin ends are chamfer for easy insertion.
- Highly durable with excellent compressive strength.
- Consistent quality / factory finish and good dimensional stability.
- Negligible moisture absorption.
- 100% fungus and termite proof.
- Manufactured by latest technology.
- Available in PVC & Normal Wood



BED FITTING

Code	Size(mm)	MRP
EE-650A-BF-900	900 x 5	4200
EE-650B-BF-1500	1500 x 5	5000

Product Features

- Ideal solution for beds with storage
- Includes pro-lift bed fitting easy fit extended arm
- 30 degree opening angle allows easy excess
- 900mm with 90n & 125n hydraulic pump
- 1500mm with 150n & 200n hydraulic pump
- Convenient to lift with minimum force

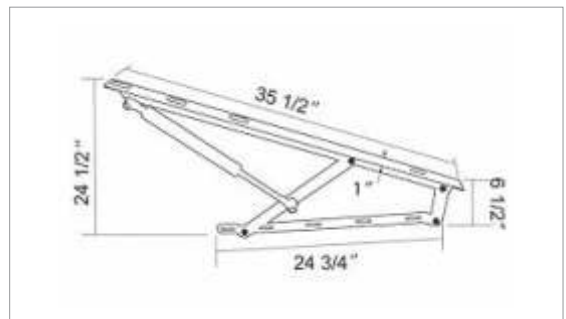

GAS PUMP



Code	Weight Capacity	MRP
EE-661A-GP-5	5 kgs	145
EE-661B-GP-8	8 kgs	145
EE-661C-GP-10	10 kgs	145
EE-661D-GP-12	12 kgs	145
EE-661E-GP-15	15 kgs	145

Product Features

- For easy opening of wooden fronts
- Great choice to operate overhead cabinets allowing the perfect access
- Can be used on one or both sides
- Concealed hinges must be fitted at the top of the flap



GAS PUMP SOFT OPENING AND SOFT CLOSING

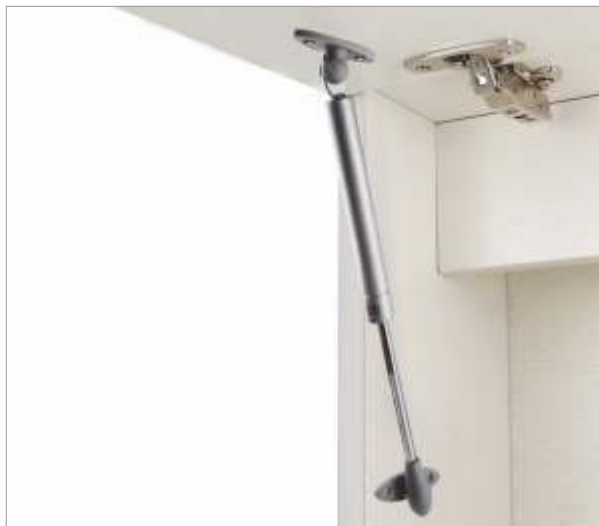

Code	Weight Capacity	MRP
EE-662A-GP-SC-5	5 kgs	290
EE-662B-GP-SC-10	10 kgs	290
EE-662C-GP-SC-15	15 kgs	290

Product Features

- For easy opening of wooden fronts
- Great choice to operate overhead cabinets allowing the perfect access
- Soft close & soft opening
- Can be used on one or both sides
- Concealed hinges must be fitted at the top of the flap



FLAP STAY



Code	Weight Capacity	MRP
EE-663-FS-8	8 kgs	2000

Product Features

- Can be used in left or right
- Weight capacity 8 kgs
- Can be held at 90 degrees
- For door size:-
400-700x400mm use 1 pcs
- For door size:-
900-1200x400mm use 2 pcs





- Matt Black
- Iron Grey
- Matt Rose Gold
- Satin
- Mirror
- Gold Brush

G Profile
Rose Gold Shine
Gold Brush
Matt Black
Champagne Brush
Iron Grey
CP Mirror

@MRP 1900

ALUMINIUM FRAME PROFILE

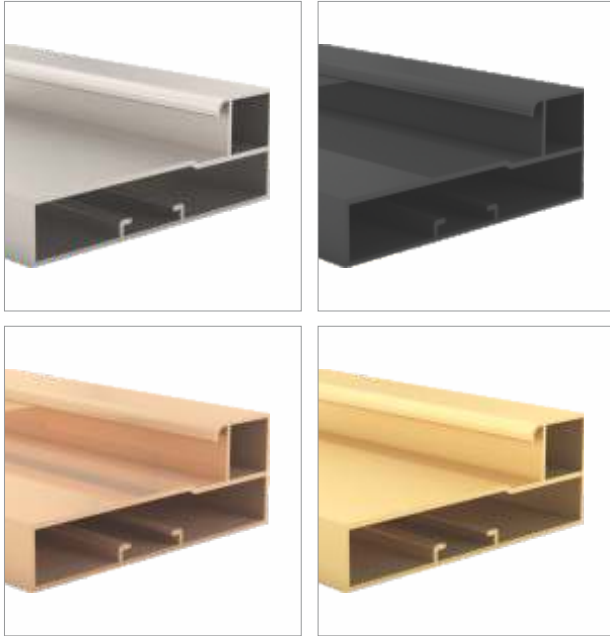

Finish	Length	MRP
Silver	10ft	2850
Rose Gold Shiny	10ft	2850
Gold Brush	10ft	2850
Matt Black	10ft	2850

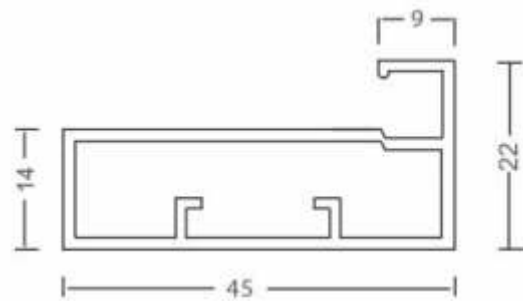

ALUMINIUM G-HANDLE FRAME PROFILE



Finish	Length	MRP
Silver	10ft	4450
Rose Gold Shiny	10ft	4450
Gold Brush	10ft	4450
Matt Black	10ft	4450

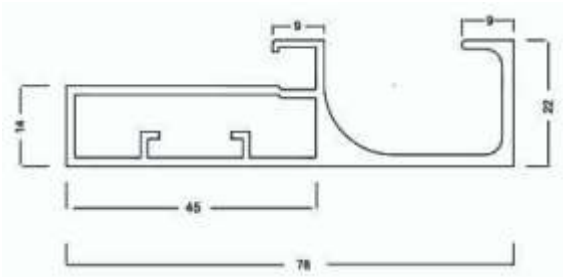

ALUMINIUM PROFILE CONNECTORS



Code	Product	MRP
EP 802 CNT	Connector	160

ALUMINIUM C-PROFILE



Finish	Length	MRP
Silver	10ft	2350
Matt Black	10ft	2650



ALUMINIUM J-PROFILE

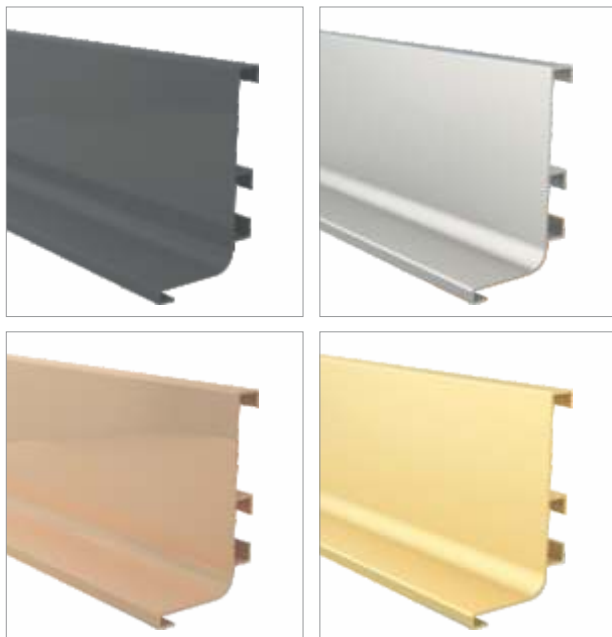

Finish	Length	MRP
Silver	10ft	2150
Matt Black	10ft	2450



ALUMINIUM PROFILE CONNECTORS FOR 22MM



Code	Product	MRP
EP 802 CNT	Connector	160

ALUMINIUM NEW FRAME PROFILE 45MM



Finish	Length	MRP
Mirror Shiny	10ft	2400
Matt Black	10ft	2400

ALUMINIUM I HANDLE PROFILE 45MM



Finish	Length	MRP
Mirror Shiny	10ft	2600
Matt Black	10ft	2600

SLIM GLASS PROFILE 22MM



Finish	Length	MRP
Brush Copper	10ft	3300
Matt Black	10ft	2900

HANDLE 120MM FOR 22MM PROFILE



Finish	MRP
Brush Copper	700
Matt Black	650

PVD PROFILES (FLAT)

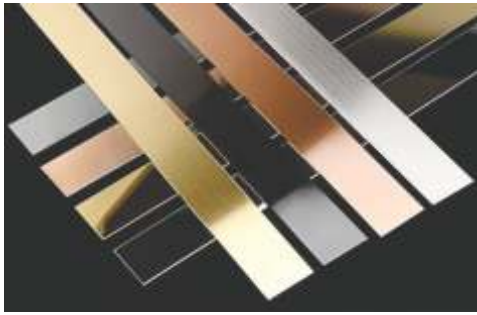

Size (mm)	8 Feet	10 Feet
12	112	147
18	157	211
25	232	302
38	355	462
50	462	600
75	699	910
100	934	1214

PVD PROFILES (U)

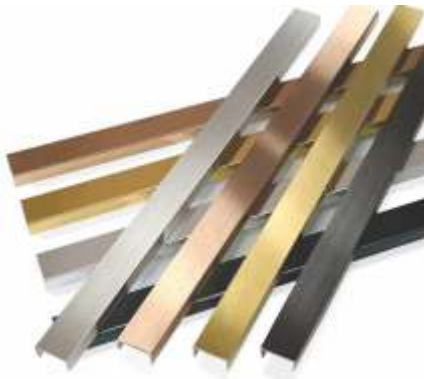

Size (mm)	8 Feet	10 Feet
6	254	331
12	310	403
25	512	667
40	656	854

PVD PROFILES (T)



Size (mm)	8 Feet	10 Feet
8	640	832
12	614	798
19	734	955
25	787	1024

PVD PROFILES (L)



Size (mm)	8 Feet	10 Feet
12	267	347
19	395	512

LOUVERS



Length	8 Feet	10 Feet
Width	4"	4"
Price	2534	3200

ANTI SKID RUBBER MATT



Code	Colour & Size	MRP
EA-900A-RM-DG	Dark Grey (20" x 20 Mtrs)(Diamond)	8000
EA-900B-RM-LG	Light Grey (20" x 20 Mtrs)	8000
EA-900C-RM-TP	Transparent (20" x 20 Mtrs)	8000
EA-900D-RM-BK	Black(20" x 20 Mtrs)	8000
EA-900E-RM-BG	Beige (20" x 20 Mtrs)	8000
EA-900F-RM-FG	Fabric Grey (20" x 20 Mtrs)	9000

Product Features

- Size : 50cm x 2000cm (20 meters) roll. You can cut it according to your need
- Made of edible food-graded EVA (ethylene-vinyl), BPA-free, non adhesive with standard insulation function
- Odour & stains-free, mildew and moisture-free, waterproof & antibacterial
- Suitable for kitchen, drawer, cupboard, table, refrigerator, shelves. More thick than usual pads. Durable for home keeping



SHELF SUPPORT FOR WOODEN OR GLASS SHELF



Product	Code	Finish	MRP
ABS	EA-901A-SS-ABS	Clear	3
ABS	EA-901B-SS-ABS	Brown	3
Light Weight	EA-901C-SS-LW	Chrome	9
Medium Weight	EA-901D-SS-MW	Chrome	9
Heavy Weight	EA-901E-SS-HW	Chrome	9

Product Features

- Simple, cost effective and easy to fit
- Forged for core strength.
- Provides good support to the shelves in cabinets
- Aesthetically adds beauty to the shelves in the cabinets



CABINET PVC LEGS



Product/Size	Code	MRP
PVC Leg-100mm	EA-902A-APL-100	45
PVC Leg-150mm	EA-902B-APL-150	90
PVC Bracket Connector	EA-902C-PLBC	10

Product Features

- Height adjustment legs with adjustment upto 40mm
- Available sizes 100mm & 150mm
- Levels out irregularities in the carcass & makes the entire cabinet stand on the same plane
- Bracket connector is easy to slide in to the skirting & clip to the legs
- Holds cabinet weight easily
- Finish black

Packaging 200 Pcs Per Bag

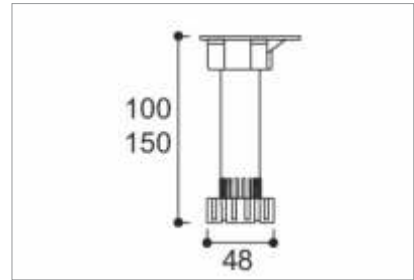
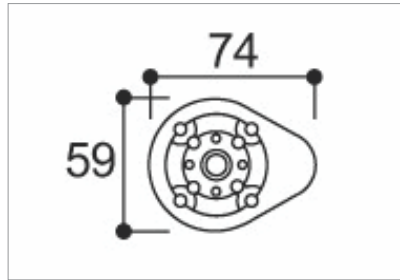

SKIRTING



Product/Size(mm)	Finish	Code	MRP
Skirting -100	Aluminium Brush	EA-923A-SKT-100	1100
Skirting -100	Black	EA-923D-SKT-100	1200
Elbow-100	Aluminium Brush	EA-923B-EB-100	120
Elbow-100	Black	EA-923E-EB-100	130

Product Features

- PVC skirting is mainly used in kitchen cabinets
- Broad rubber seal protects from dust & water from settling below the cabinets
- Available sizes 100mm & 150mm
- Available in aluminium brush & black finish

Packaging 15 Pcs Per Bag

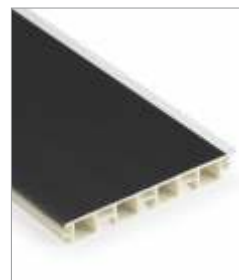

PUSH TO OPEN



Product	Code	MRP
with Wings	EA-904A-PO-W	80
with Separate Base	EA-904B-PO-SB(Heavy)	140

Product Features

- Ideal for drawers & shutters without handles
- Drawer / shutters remains closed with magnetic pull
- Easy screw on adaptor plate
- Adjustable distance 4mm

Packaging 200 Pcs Per Bag

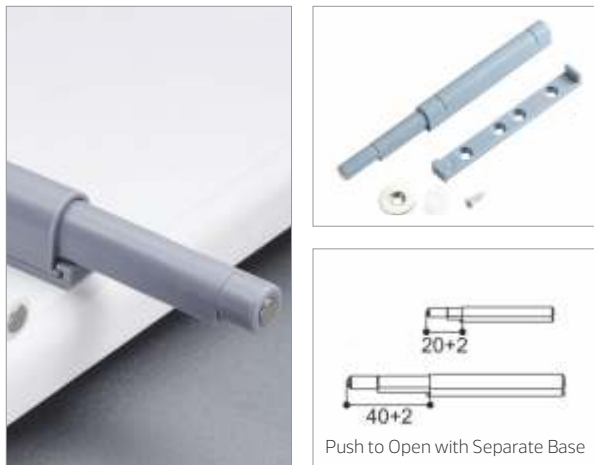

Packaging 100 Pcs Per Bag

DAMPNER



Product	Code	MRP
Concealed Round Dampner	EA-905-DP	140

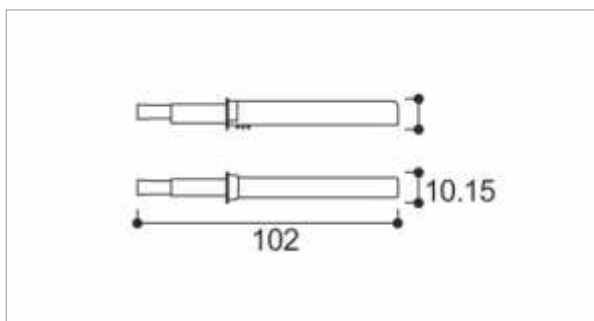

MINI FIX



Code	Size(mm)	MRP
EA-906-MFX	42	13

Product Features

- Easy and rapid installation.
- Half turn locking.
- Rotor screw is manufactured out of cold forged steel for strength, eliminating chances of breakage.
- The multi - functional plastic enables the screw to be held while fixing with a pneumatic screw driver as well as a perfect fit in the pre - drilled hole.
- It consists of two parts : a zinc cam and a steel or composite bolt that conduct the 'fastening function'.
- Wooden dowels are also available.

Packaging 3 Pcs Set

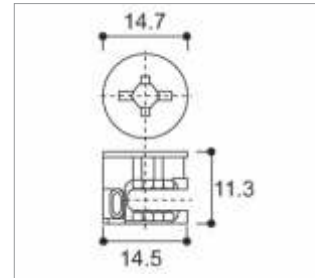

CABINET HANGING BRACKET



Product/Colour	Code	MRP
Cabinet Hanging Bracket-Heavy/White	EA-907-HB	180

Product Features

- Used for hanging the cabinet & frames to the wall
- Easy to fit.
- Can use in multiples of two for bigger cabinets & frames.
- Easy to align & adjust the cabinet with the help of adjustment screw
- Comes with cover which concealed all screws

Packaging Single Piece

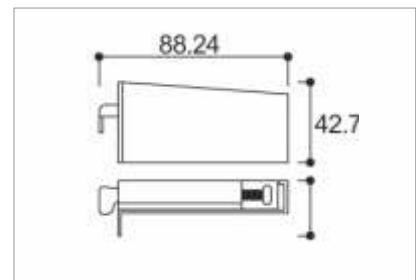



DOUBLE DOOR SOFT CLOSE FITTING

SKY TRACK IN BLACK COLOUR

Product	MRP
Double Door soft close Wheel - Light	2300/-
Double Door soft close Wheel - Medium	2750/-

Product	Size(ft)	MRP
Double Top & Bottom Track	8ft	3400/-
Double Top & Bottom Track	13ft	5500/-



Double Door soft close Wheel - Light



Double Door soft close Wheel - Medium

JEWELLERY BOX



Size	MRP
600mm	7500
900mm	8500

WARDROBE GLASS BASKET



Size	MRP
450mm	7500
600mm	8500
900mm	9000

TROUSER PULLOUT



Size	MRP
600mm	6500
900mm	7500

SHOE PULLOUT DOUBLE PREMIUM



Size	MRP
600mm	7000
900mm	8500

HANGER PULL OUT



Code	Cabinet Size(mm)	MRP
EW-722-HP	800 to 1000	6200

Product Features

- Strong chrome steel rod and arms with a black plastic housing
- Heavy duty wardrobe closet lift allows you to reach high hanging clothes easily. You simply pull the handle and the clothing comes to you
- Utilize all the space in your closet by hanging cloths all the way to the ceiling
- All the necessary mounting hardware is included



GLASS WARDROBE BASKET MOCHA



Code	Size(mm)	MRP
EW-726D-WRB- 600QD-GL	600 (564 x 465 x 180)	13000
EW-726E-WRB- 600QD-GL	900 (864 x 465 x 180)	15000

Product Features

- Modern fashion appearance
- Concealed silent soft closing mechanism
- Width of the frame is adjustable for 50mm
- Mocha color and toughened glass

JEWELRY TRAY MOCHA



Code	Size(mm)	MRP
EW-729A-JT600-BW	600 (564 x 465 x 76)	13000
EW-729B-JT900-BW	900 (864 x 465 x 76)	15000

Product Features

- Modern fashion appearance
- Concealed silent soft closing mechanism
- Width of the frame is adjustable for 50mm
- Mocha color
- The combination of wooden colours brings a whole new definition to wardrobe

TROUSER RACK MOCHA



Code	Size(mm)	MRP
EW-724D-TR-BW	(350 x 455 x 115)	8000

Product Features

- Push pull design is more convenient to receive clothes
- Concealed silent soft closing mechanism
- Mocha color
- Soft elastic protection of the clothes

TROUSER DOUBLE RACK-TOP MOUNTED MOCHA



Code	Size(mm)	MRP
EW-724E-TR2-BW	(650 x 455 x 115)	9000

Product Features

- Push pull design is more convenient to receive clothes
- Concealed silent soft closing mechanism
- Mocha color
- Soft elastic protection of the clothes

TROUSER PULL OUT MOCHA



Code	Size(mm)	MRP
EW-724B-600QD-TRP-BW	(564 x 465 x 76)	9500
EW-724C-900QD-TRP-BW	(864 x 465 x 76)	10500

Product Features

- Push pull design is more convenient to receive clothes
- Concealed silent soft closing mechanism
- The combination of wooden colours brings a whole new definition to wardrobe
- Width of the frame is adjustable for 50mm

HANGER PULL DOWN MOCHA



Code	Size(mm)	MRP
EW-722A-HPBW	(830 - 1150)	10000

Product Features

- Hydraulic design easy to pull down
- Concealed silent soft closing mechanism
- Mocha colour

CLOTH HOLDER-TOP MOUNTED MOCHA



Code	Size(mm)	MRP
EW-722B-CH	(115 x 455 x 115)	6500

Product Features

- Top mounted cloth holder to create extra ordinary space
- Push pull design is more convenient to receive clothes
- Concealed silent soft closing mechanism
- Mocha colour

PULL OUT MIRROR



Code	Size(mm)	MRP
EW-727-POM	1000 x 350	7000

Product Features

- Easy to operate, easy to rotate
- No need to change position of clothes hanging in the wardrobe

IRON BOARD



Code	Size(mm)	MRP
EW-731-IB	800 to 1000	10000

Product Features

- The panel can rotate at 90 degree
- Push pull folding, pullout & turn when used
- Fold back when not used

SHOE PULL OUT -DOUBLE LAYER MOCHA



Code	Size(mm)	MRP
EW-725C-600QD-SHP2-BW	600 (564 x 465 x 175)	10000
EW-725D-900QD-SHP2-BW	900 (864 x 465 x 175)	12000

Product Features

- Smoothness & cleanliness to the user
- Concealed silent soft closing mechanism
- The combination of colours brings a whole new definition to wardrobe
- Width of the frame is adjustable for 50mm

ROTATING SHOE RACK MOCHA

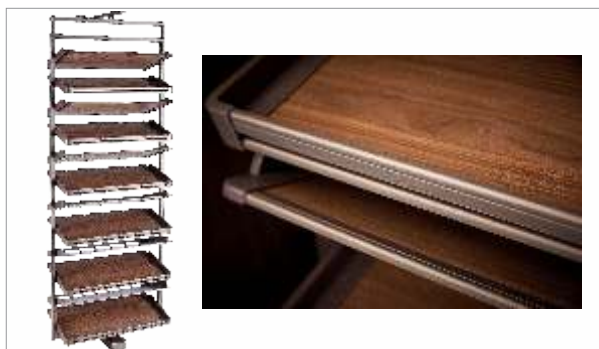

Code	Size(mm)	MRP
EW-728A-RSR8-BW	8 Layer (700 x 360 x 1350-1550)	31000
EW-728B-RSR12-BW	12 Layer (700 x 360 x 1910-2110)	32000

Product Features

- 360 degree revolving
- Smoothness & cleanliness to the user
- Maximum use of space, split layer design can hold more
- Concealed silent soft closing mechanism
- The combination of colours brings a whole new definition to wardrobe
- The height of the frame is adjustable to 200mm

Innovation, Elegance, Quality...!

E-Box & Slim Box



Drawer Slides



Baskets



Pantry Units



Corner Units



BPO & MPO



Pull Down & Rolling Shutter



Cutlery & Wicker



Rack & Bins



Midway System



Hinges



Elevators



Wardrobe & Accessories



Profiles & Handles



Ancillaries





STERLING HOME INNOVATOR PVT. LTD.

*D-88, Sector-16, HSIIDC Bahadurgarh,
Haryana - 124507*

Website : www.sterlingwp.com

Customer Care No. 8059843498/8570066253

